



2023

# AERO INDIA

The Runway to a Billion Opportunities

13<sup>th</sup> - 17<sup>th</sup> February 2023

Air Force Station, Yelahanka, Bengaluru  
Karnataka, India

## Exhibitor Directory



# AERO INDIA 2023 Layout



**AERO INDIA**  
2023  
The Runway to a Billion Opportunities

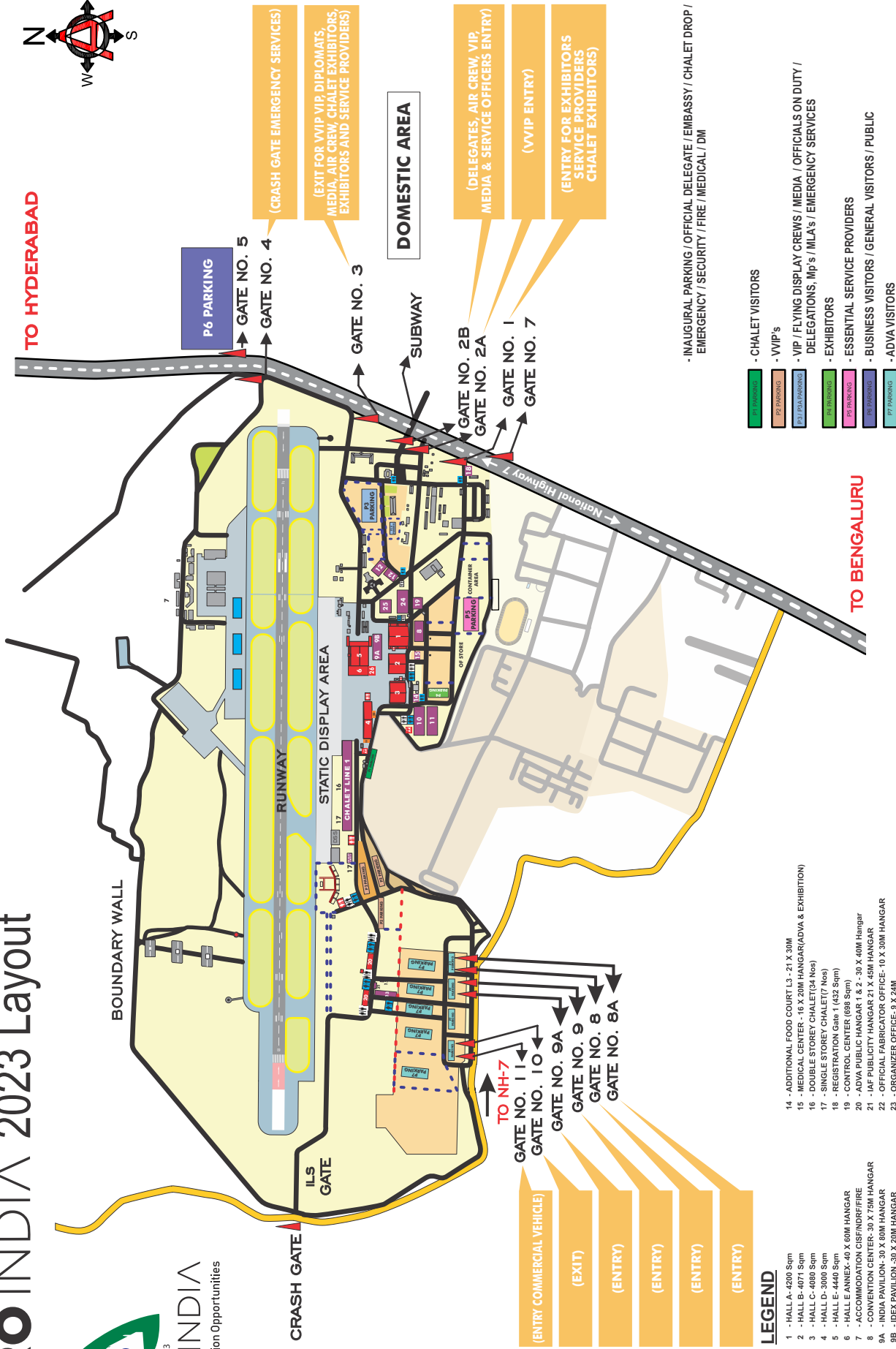
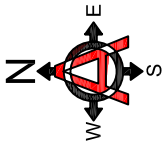

- 1 - HALL A- 4200 Sqm
- 2 - HALL B- 4071 Sqm
- 3 - HALL C- 4880 Sqm
- 4 - HALL D- 3000 Sqm
- 5 - HALL E- 4440 Sqm
- 6 - HALL E ANNEX- 40 X 60M HANGAR
- 7 - ACCOMMODATION DISPENSARY
- 8 - CONVENTION CENTER- 30 X 75M HANGAR
- 9A - INDIA PAVILION- 30 X 60M HANGAR
- 9B - IDEX PAVILION- 30 X 20M HANGAR
- 10 - FOODCOURT L1- 30 X 70M HANGAR
- 11 - FOODCOURT L2- 30 X 70M HANGAR
- 12 - FOODCOURT L3- 15 X 40M & 30 X 40M HANGAR
- 13 - ADVA FOOD COURT- 30 X 70M HANGAR
- 14 - ADDITIONAL FOOD COURT L3- 21 X 30M
- 15 - MEDICAL CENTER - 15 X 20M HANGAR(ADVA & EXHIBITION)
- 16 - DOUBLE STOREY CHALET(4 Nos)
- 17 - SINGLE STOREY CHALET(7 Nos)
- 18 - REGISTRATION GATE 1 (832 Sqm)
- 19 - CONTROL CENTER (698 Sqm)
- 20 - ADVA PUBLIC HANGAR 1 & 2 - 30 X 40M HANGAR
- 21 - IAF PUBLIC HANGAR 21 X 45M HANGAR
- 22 - OFFICIAL FABRICATOR OFFICE- 10 X 30M HANGAR
- 23 - ORGANIZER OFFICE- 9 X 24M
- 24 - HALL G EXHIBITION- 40 X 70M HANGAR
- 25 - HALL H EXHIBITION- 40 X 40M HANGAR
- 26 - HALL I EXHIBITION- 40 X 25M HANGAR

- EXISTING TOILETS (8 Nos)
- PAGODA TOILETS (12 Nos)
- AC MOBILE TOILETS (6 Nos)
- FENCING
- BARICADING
- INTERNAL IAF FENCING
- EXTERNAL IAF FENCING
- GOLF CART CHARGING POINT

- INAUGURAL PARKING / OFFICIAL DELEGATE / EMBASSY / CHALET DROP / EMERGENCY / SECURITY / FIRE / MEDICAL / DM
- CHALET VISITORS
- VVIP's
- VIP / FLYING DISPLAY CREWS / MEDIA / OFFICIALS ON DUTY / DELEGATIONS, Mps / MLAs / EMERGENCY SERVICES
- EXHIBITORS
- ESSENTIAL SERVICE PROVIDERS
- BUSINESS VISITORS / GENERAL VISITORS / PUBLIC
- ADVA VISITORS







# CONTENTS

<b>Alphabetical List of Exhibitors</b>	<b>01 - 10</b>
<b>Hallwise List of Exhibitors</b>	<b>11 - 32</b>
<b>India Pavilion</b>	<b>33 - 36</b>
<b>Exhibitors Details</b>	<b>37 - 92</b>







# Alphabetical list of Exhibitors



# Alphabetical List of Exhibitors

EXHIBITOR	LOCATION	
AARJAY INTERNATIONAL PRIVATE LIMITED	HALL A	A3.12
AAVIZA ELECTRONICS PRIVATE LIMITED	HALL C	C1.1
ACCIAIERIE VALBRUNA S.P.A	HALL B	B5.27
ACCORD GLOBAL TECHNOLOGY SOLUTIONS PRIVATE LIMITED	HALL A	A1.13
ACCORD IDEATION PRIVATE LIMITED	HALL A	A1.12
ACCORD SOFTWARE AND SYSTEMS PRIVATE LIMITED	HALL A	A1.11
ACCURATE SALES & SERVICES PRIVATE LIMITED	HALL C	C1.3,1.4
ACUTRONIC INDIA PRIVATE LIMITED	HALL F	F1.6
ADANI DEFENCE SYSTEMS AND TECHNOLOGIES LIMITED	HALL C	C7.2,7.3,7.4,7.5
ADDEV MATERIALS PRIVATE LIMITED	HALL C	C1.12
ADRYS TECHNOLOGIES	HALL A	A3.1, 3.2
AERO REL SYSTEMS PRIVATE LIMITED	HALL F	F2.2
AEROSUN MEDIA PRIVATE LIMITED	HALL C	C3.3
AGNI CONTROLS	HALL C	C3.6
AIRBORN INTERNATIONAL	HALL G	G4.7
AIRBUS SAS	HALL C	C7.1
AMADO TOOLS	HALL F	F3.14
AMETEK INDIA	HALL H	H4.3
AMI METALS UK LIMITED	HALL F	F4.6,4.7
AMPHENOL INTERCONNECT INDIA PRIVATE LIMITED	HALL A	A8.4
ANANYA TECHNOLOGIES PRIVATE LIMITED	HALL A	A1.3
ANIL METALS & ALLOYS PRIVATE LIMITED	HALL C	C3.8,3.9
ANJANA ENGINEERING WORKS	HALL G	G2.2
ANKIT AEROSPACE PRIVATE LIMITED	HALL B	B1.2
APEXPLUS TECHNOLOGIES PRIVATE LIMITED INDIA	HALL F	F1.7
APOLLO AEROSPACE COMPONENTS INDIA PRIVATE LIMITED	HALL F	F2.7
APOLLO MICRO SYSTEMS LIMITED	HALL F	F5.7,5.8
AQUASCAPE ENGINEERS PRIVATE LIMITED	HALL A	A3.4
ARMY AVIATION	HALL H	H4.1, H4.2
ARMY AVIATION	CHALET	19, 20
ASTRA MICROWAVE PRODUCTS LIMITED	HALL F	F6.1,6.2
ASTRA RAFAEL COMSYS PRIVATE LIMITED	HALL C	C4.3
ATEQ SYSTEMS ANALYTIC INDIA PRIVATE LIMITED	HALL A	A3.13



# Alphabetical List of Exhibitors

EXHIBITOR	LOCATION	
AVDEL (INDIA) PRIVATE LIMITED	HALL F	F1.9,1.10
AVIAHELP	HALL B	B5.3
AVIAZAPCHAST PLC	HALL C	C4.1
AVIOANE CRAIOVA S.A.	HALL H	H1.3
AVI-OIL INDIA PRIVATE LIMITED	HALL G	G1.6
AXIOMATIC ITECH PRIVATE LIMITED	HALL H	H2.3
AXISCADES TECHNOLOGIES LIMITED	HALL B	B1.1
AXON INTERCONNECTORS AND WIRES PRIVATE LIMITED	HALL A	A1.7, A1.6
AZAD ENGINEERING PRIVATE LIMITED	HALL A	A7.4b
AZISTA INDUSTRIES PRIVATE LIMITED	HALL F	F6.5
BASHI AEROSPACE PRIVATE LIMITED	HALL A	A1.2
BEML LIMITED	HALL E	E.3.2, E.3.3
BEVEL GEARS (INDIA) PRIVATE LIMITED	HALL B	B5.33
BHARAT DYNAMICS LIMITED	HALL E	E.4.1,4.2,4.3,4.5,4.6
BHARAT ELECTRONICS LIMITED	CHALET	39, 40
BHARAT ELECTRONICS LIMITED	OUTDOOR	OD 03
BHARAT FORGE LIMITED	CHALET	35
BIKAR AEROSPACE	HALL B	B5.29,5.30
BISEN AEROSPACE PRIVATE LIMITED	HALL C	C3.11
BLISS AEROSPACE COMPONENTS PRIVATE LIMITED	HALL A	A1.1
BLUEKEI SOLUTIONS PRIVATE LIMITED	HALL A	A1.8
BOLLHOFF FASTENINGS PRIVATE LIMITED	HALL F	F1.5
BRAHMOS AEROSPACE	HALL E	E.3.1A
BRIJ SYSTEMS LIMITED	HALL A	A2.4
CADOPTTECHNOLOGIES PRIVATE LIMITED	HALL C	C2.4
CAPTRONIC SYSTEMS PRIVATE LIMITED	HALL B	B5.23
CARRIS PIPES AND TUBES PRIVATE LIMITED	HALL B	B5.25
CINGULARITY TOOLING & ENGINEERING CONCEPTS INDIA PRIVATE LIMITED	HALL B	B5.4
COGNE ACCIAI SPECIALI SPA	HALL G	G2.5
COLLINS AEROSPACE	HALL A	A7.4a
COMAVIA SYSTEMS TECHNOLOGIES PRIVATE LIMITED	HALL C	C1.8,1.9
COMPROTECH ENGINEERING PRIVATE LIMITED	HALL F	F4.3
COMPUPOWER PRIVATE LIMITED	HALL B	B5.20,5.21

# Alphabetical List of Exhibitors

EXHIBITOR	LOCATION	
CONNEKT ELECTRONICS PRIVATE LIMITED	HALL F	F2.3,2.4
CSIR NATIONAL AEROSPACE LABORATORIES	HALL B	B3.3
DASSAULT AIRCRAFT SERVICES INDIA PRIVATE LIMITED	HALL B	B2.1
DASSAULT SYSTEMES INDIA PRIVATE LIMITED	HALL A	A5.4
DATA PATTERNS (INDIA) LIMITED	HALL A	A6.1
DATASOL BANGALORE PRIVATE LIMITED	HALL B	B5.32
DCM SHRIRAM INDUSTRIES LIMITED	HALL C	C1.5, C1.6
DEEP ENGINEERING INDUSTRIES	HALL B	B5.9
DEEPALI DESIGNS AND EXHIBITS PRIVATE LIMITED	HALL C	C5.6
DEFENCE INVESTOR CELL	HALL H	H5.7
DEFENCE RESEARCH AND DEVELOPMENT ORGANISATION	HALL D	D1, D2, D3, D4, D5,D6, D7
DEFENCE RESEARCH AND DEVELOPMENT ORGANISATION	CHALET	25 - 28
DILABS SYSTEMS PRIVATE LIMITED	HALL C	C1.10,1.11
DIRECTORATE GENERAL OF AERONAUTICAL QUALITY ASSURANCE	HALL E	E.5.2
DIRECTORATE OF STANDARDISATION	HALL A	A3.11
DR MGR EDUCATIONAL AND RESEARCH INSTITUTE	HALL F	F3.2
DYNAMATIC TECHNOLOGIES LIMITED	CHALET	37
EATON INDUSTRIAL PRODUCT PRIVATE LIMITED	HALL F	F5.4
ELBIT SYSTEMS	HALL C	C7.6
ELECTRONIC DIMENSIONS	HALL F	F1.14
ELECTRONICS CORPORATION OF INDIA LIMITED	HALL C	C1.2
ELECTROWING TECHNOLOGIES PRIVATE LIMITED	HALL H	H1.4
ELETTRONICA SPA	HALL F	F5.5
EMBRAER	HALL B	B2.2b
ENSINGER INDIA ENGINEERING PLASTICS PRIVATE LIMITED	HALL C	C2.9
ETERNUS PERFORMANCE MATERIALS PRIVATE LIMITED	HALL C	C3.7
EXICOM TECHNOLOGIES INDIA LLP	HALL A	A2.3
EXPLEO TECHNOLOGIES INDIA PRIVATE LIMITED	HALL C	C4.4
FABHEADS AUTOMATION PRIVATE LIMITED	HALL F	F3.10
FDH AERO	HALL C	C2.11
FEDEX EXPRESS TRANSPORTATION & SUPPLY CHAIN SERVICES (INDIA) PRIVATE LIMITED	HALL H	H4.8a
FLIGHT SIMULATION TECHNIQUE CENTRE	HALL F	F3.7, F3.8
FOKKER ELMO SASMOS INTERCONNECTION SYSTEMS LIMITED	HALL H	H2.6

# Alphabetical List of Exhibitors

EXHIBITOR	LOCATION	
FORCE NEWS MAGAZINE	HALL F	F3.5
FUTURE METALS LLC	HALL B	B5.5
GARG ASSOCIATES PRIVATE LIMITED	HALL A	A4.3
GENSER AEROSPACE & IT PRIVATE LIMITED	HALL G	G3.4
GIFAS	HALL B	B3.2,4.1 ,4.2
GLENAIR INC	HALL G	G2.7,2.6
GLIDERS INDIA LIMITED	HALL E	E.5.4
GLODESI TECHNOLOGIES PRIVATE LIMITED	HALL H	H2.4
GODREJ & BOYCE MANUFACTURING COMPANY LIMITED	HALL B	B2.2c
GOPALAN AEROSPACE INDIA PRIVATE LIMITED	HALL F	F6.3
HARYANA AIRPORT DEVELOPMENT CORPORATION	HALL E	E5.5
HARYANA GOVERNMENT	CHALET	38
HC ROBOTICS	HALL F	F3.1
HEAD QUARTERS INTEGRATED DEFENCE STAFF	CHALET	11
HICAL TECHNOLOGIES PRIVATE LIMITED	HALL A	A8.5
HILD DEFENCE AND AEROSPACE PRIVATE LIMITED	HALL H	H3.2
HIMANSHI THERMAL SOLUTIONS	HALL A	A3.10
HIND SALES CORPORATION	HALL B	B5.8
HINDUSTAN AERONAUTICS LIMITED	HALL E	E.2.1 - 2.4
HINDUSTAN AERONAUTICS LIMITED	CHALET	21 - 24
HINDUSTAN AERONAUTICS LIMITED	OUTDOOR	OD 01, 02
HINDUSTAN INSTITUTE OF TECHNOLOGY AND SCIENCE	HALL F	F4.1
HI-REL TECH PRIVATE LIMITED	HALL B	B5.26
HTL LIMITED	HALL G	G4.2
HYPERCOAT ENTERPRISES PRIVATE LIMITED	HALL B	B5.17A
HYT INNOVATIVE PROJECTS PRIVATE LIMITED	HALL G	G1.7
INDIAN AIR FORCE	HALL E	E.5.1
INDIAN AIR FORCE	CHALET	13 - 16
INDIAN INSTITUTE OF MANAGEMENT BANGALORE	HALL H	H5.6
INDIAN NAVY	CHALET	17, 18
INDO AEROSPACE SOLUTIONS PRIVATE LIMITED	HALL A	A2.6
INDO WINGS PRIVATE LIMITED	HALL H	H3.4
INDO-GERMAN CHAMBER OF COMMERCE	HALL F	F5.6, F6.6



# Alphabetical List of Exhibitors

EXHIBITOR	LOCATION	
INNOVATION COMMUNICATIONS SYSTEMS LIMITED	HALL A	A1.10
INTEGRAL SYSTEMS AND COMPONENTS PRIVATE LIMITED	HALL F	F1.11
INVESTMENT & PRECISION CASTINGS LIMITED	HALL B	B5.12
ISRAEL AEROSPACE INDUSTRIES LIMITED	HALL F	F5.1,5.2
JAS PROPAC INC	HALL F	F2.5
JAYEM TRADE PRIVATE LIMITED	HALL A	A3.8
JISNU COMMUNICATIONS PRIVATE LIMITED	HALL F	F2.6
JJG AERO PRIVATE LIMITED	HALL C	C4.6
JNR AEROSPACE INDIA PRIVATE LIMITED	HALL G	G3.1
JSC IT CONCEPTS INDIA PRIVATE LIMITED	HALL H	H2.1
KALAPURNA STEEL & ENGG PRIVATE LIMITED	HALL C	C2.6, C2.7, C2.8
KALLMAN WORLDWIDE INC	HALL A	A4.4,4.5,5.1,5.2,5.3,6.3, 7.2
KALLMAN WORLDWIDE INC	CHALET	32
KALYANI RAFAEL ADVANCED SYSTEMS PRIVATE LIMITED	HALL C	C5.3
KAPASI-SOUTHCO, INDIA	HALL F	F4.5
KARNATAKA UDYOG MITRA, GOVERNMENT OF KARNATAKA	HALL E	E.1.1
KARNATAKA UDYOG MITRA, GOVERNMENT OF KARNATAKA	CHALET	12
KINGSLY INSTRUMENTATION & COMMUNICATION PRIVATE LIMITED	HALL F	F1.1
KUSUMGAR CORPORATES PRIVATE LIMITED	HALL G	G2.3,2.4
KWI	HALL A	A6.2
LAKSHMI VACUUM TECHNOLOGIES PRIVATE LIMITED	HALL G	G4.6
LAVERSAB INDIA	HALL A	A3.6, A3.7
LEACH INTERNATIONAL EUROPE SAS	HALL G	G4.3
LEGEND TECHNOLOGIES INDIA PRIVATE LIMITED	HALL F	F2.1
LEONARDO	HALL F	F6.7
LHG SPECIALITY STEEL INTERNATIONAL PRIVATE LIMITED	HALL A	A4.7,4.8,4.9
LPSIS PRIVATE LIMITED	HALL H	H4.6
MAINI MATERIALS MOVEMENT PRIVATE LIMITED	HALL B	B4.3
MBDA	HALL B	B3.1
MERLINHAWK AEROSPACE PRIVATE LIMITED	HALL B	B1.3
METAL EXTRUSIONS	HALL B	B5.16
MIKROFLO FILTERS PRIVATE LIMITED	HALL G	G3.7
MINISTRY OF DEFENCE	CHALET	01 - 08

# Alphabetical List of Exhibitors

EXHIBITOR	LOCATION	
MISHRA DHATU NIGAM LIMITED	HALL E	E.5.3
MISOCHAIN TECHNOLOGIES PRIVATE LIMITED	HALL H	H5.3
MISSION AEROSPACE FOUNDATION OF INDIA	HALL G	G3.5
MKU LIMITED	HALL A	A7.3a
MRF LIMITED	HALL F	F6.8
MULTIPLE SPECIAL STEEL PRIVATE LIMITED	HALL H	H5.5
MUNITIONS INDIA LIMITED	HALL E	E.3.4
NASMYTH ASIA (INDIA) PRIVATE LIMITED	HALL F	F1.2
NEWSEYE MEDIA PRIVATE LIMITED	HALL G	G4.1
NEWSPACE RESEARCH AND TECHNOLOGIES PRIVATE LIMITED	HALL C	C5.2
NEXT DEFENCE PRIVATE LIMITED	HALL F	F4.4
NICOMATIC INDIA ELECTRONICS PRIVATE LIMITED	HALL A	A2.10
NIVOX TECHNOLOGIES	HALL F	F3.9
NOBLE AEROSPACE PRIVATE LIMITED	HALL B	B5.14
NUCON AEROSPACE PRIVATE LIMITED	HALL F	F3.13
NUCON ALKAN AEROSPACE PRIVATE LIMITED	HALL F	F3.11
NUCON PNEUMATICS PRIVATE LIMITED	HALL F	F3.12
ORIENTAL WEAVING & PROCESSING MILLS PRIVATE LIMITED	HALL B	B5.24
PARAS WIRES PRIVATE LIMITED	HALL F	F3.4
PAWAN HANS LIMITED	HALL B	B5.17C
PBS INDIA PRIVATE LIMITED	HALL B	B5.10, B5.11
PEI-GENESIS	HALL G	G4.5
PINAKA AEROSPACE SOLUTIONS PRIVATE LIMITED	HALL C	C2.1, C2.2, C2.3
PROCESSWARE SYSTEMS PRIVATE LIMITED	HALL G	G3.2
PRODIGY TECHNOVATIONS PRIVATE LIMITED	HALL A	A2.5
PTC INDUSTRIES LIMITED	HALL C	C4.2
PUSHPAK INDUSTRIAL SERVICES	HALL A	A1.4
PUSHPAK PRODUCTS INDIA PRIVATE LIMITED	HALL A	A1.5
RADDEF PRIVATE LIMITED	HALL C	C1.7
RADEL ADVANCED TECHNOLOGY PRIVATE LIMITED	HALL C	C3.12
RADIALL INDIA PRIVATE LIMITED	HALL F	F1.8
RAFAEL ADVANCED TECHNOLOGY PRIVATE LIMITED	HALL C	C5.4, C5.5
RAFALE INTERNATIONAL	CHALET	29, 30

# Alphabetical List of Exhibitors

EXHIBITOR	LOCATION	
RANGSONS AEROSPACE PRIVATE LIMITED	HALL A	A7.3b
RATNAMANI METALS AND TUBES LIMITED	HALL H	H3.3
RAY-Q INTERCONNECTION TECHNOLOGIES INDIA PRIVATE LIMITED	HALL A	A2.7, A2.8
REUTECH INDIA PRIVATE LIMITED	HALL B	B5.28
ROLLS-ROYCE	CHALET	31
ROSOBORONEXPORT JSC	CHALET	33
ROSOBORONEXPORT JSC	HALL B	B2.3
ROTARY CONNECTORS PRIVATE LIMITED	HALL A	A2.1
ROTARY ELECTRONICS PRIVATE LIMITED	HALL A	A2.2
SAAB	HALL C	C6.1
SAAB	OUTDOOR	OD 06
SAARC TOOL TECH PRIVATE LIMITED	HALL B	B5.15
SAMANVEE TECHNOLOGIES	HALL H	H2.8
SANGHVI AEROSPACE PRIVATE LIMITED	HALL A	A3.5
SANPAR MICROFILTERS PRIVATE LIMITED	HALL B	B5.22
SAP MEDIA WORLDWIDE LIMITED	HALL G	G4.4
SASMOS HET TECHNOLOGIES LIMITED	HALL H	H2.5
SCANDRON PRIVATE LIMITED	HALL H	H4.7
SCIENTIFIC MICROWAVE	HALL A	A4.6
SCONCE GLOBAL PRIVATE LIMITED	HALL B	B5.6, B5.7
SEC INDUSTRIES PRIVATE LIMITED	HALL G	G1.1
SFO TECHNOLOGIES PRIVATE LIMITED	HALL A	A1.9
SIKA INTERPLANT SYSTEMS LIMITED	HALL B	B2.2a
SKANDA AEROSPACE TECHNOLOGY PRIVATE LIMITED	HALL F	F4.2
SKL INDIA PRIVATE LIMITED	HALL H	H2.7
SMITHS INTERCONNECT INDIA PRIVATE LTD	HALL G	G1.4
SMPP PRIVATE LIMITED	HALL B	B2.2d
SOFTEC SERVICES	HALL B	B5.18
SOUTHERN ELECTRONICS (BANGALORE) PRIVATE LIMITED	HALL F	F1.13
SOUTHFIELD PAINTS LIMITED	HALL C	C5.1
SP GUIDE PUBLICATIONS PRIVATE LIMITED	HALL C	C1.13
STAR HENTZEN COATINGS PRIVATE LIMITED	HALL H	H5.2
STAR PAINT & OIL INDUSTRIES	HALL H	H5.1



# Alphabetical List of Exhibitors

EXHIBITOR	LOCATION	
STAR WIRE INDIA LIMITED	HALL A	A2.9
STEIN SEAL COMPANY INDIA PRIVATE LIMITED	HALL C	C3.10
STRONGFIELD TECHNOLOGIES INDIA PRIVATE LIMITED	HALL A	A3.3
SUMAN CONTROLS PRIVATE LIMITED	HALL F	F1.12
SWASTIK OIL PRODUCTS MFG NAVSARI PRIVATE LIMITED	HALL H	H3.1
TAMBOLI CASTINGS LIMITED	HALL C	C2.5
TAMIL NADU INDUSTRIAL DEVELOPMENT CORPORATION	HALL A	A6.4,7.1,8.6,8.7
TARANG KINETICS PRIVATE LIMITED	HALL C	C3.4
TARGET AERO PRIVATE LIMITED	HALL G	G3.3
TATA ADVANCED SYSTEMS LIMITED	HALL G	G5.1 - 5.6
TE CONNECTIVITY INDIA PRIVATE LIMITED	HALL C	C4.5
TECHERA ENGINEERING (INDIA) PRIVATE LIMITED	HALL C	C2.10
TECNOMIC COMPONENTS PRIVATE LIMITED	HALL G	G1.5
TESBL AEROSPACE	HALL G	G2.1
THE ACCESSORIES	HALL B	B5.17B
THE BHOR CHEMICALS AND PLASTICS PRIVATE LIMITED	HALL B	B5.1
THE SOCIETY FOR AEROSPACE STUDIES	HALL A	A4.1
THERMOVAC AEROSPACE PRIVATE LIMITED	HALL F	F3.6
THIRD WAVE RUGGEDTECH PRIVATE LIMITED	HALL A	A3.9
THREYE INTERACTIVE PRIVATE LIMITED	HALL C	C6.2
TIMETOOTH TECHNOLOGIES PRIVATE LIMITED	HALL B	B5.31
TRASCCON INTERCONNECTION SYSTEMS PRIVATE LIMITED	HALL B	B5.13
TRENTAR PRIVATE LIMITED	HALL F	F5.3
TRIDENT INFOSOL PRIVATE LIMITED	HALL A	A4.10, A4.11
TROOP COMFORTS LIMITED	HALL E	E.4.4, E.4.7
TURBO CAST INDIA PRIVATE LIMITED	HALL H	H1.1
TURBO INDIA INTERCONNECT SOLUTIONS LLP	HALL A	A2.11
TURBO2 CAST PRIVATE LIMITED	HALL H	H1.2
UAC	CHALET	34
UCAM PRIVATE LIMITED	HALL B	B5.19
UNIFIED ELECTRO TECH PRIVATE LIMITED	HALL C	C3.1, C3.2
UNIFIED GLOBALTECH (I) PRIVATE LIMITED	HALL G	G3.6
UTTAR PRADESH EXPRESSWAYS INDUSTRIAL DEVELOPMENT AUTHORITY	HALL E	E.3.1B

# Alphabetical List of Exhibitors

EXHIBITOR	LOCATION	
V J IMAGING TECHNOLOGIES PRIVATE LIMITED	HALL G	G1.2,1.3
V V HITECH INNOVATIONS INDIA PRIVATE LIMITED	HALL B	B5.17
VAR ELECTROCHEM PRIVATE LIMITED	HALL B	B5.2
VEER-O-METALS PRIVATE LIMITED	HALL A	A4.2
VEM TECHNOLOGIES PRIVATE LIMITED	HALL C	C6.3
VINYAS INNOVATIVE TECHNOLOGIES PRIVATE LIMITED	HALL H	H2.2
ZEALTEK ENTERPRISES PRIVATE LIMITED	CHALET	41
ZEN TECHNOLOGIES LIMITED	CHALET	36
ZEPHYR AEROSPACE PRIVATE LIMITED	HALL F	F3.3

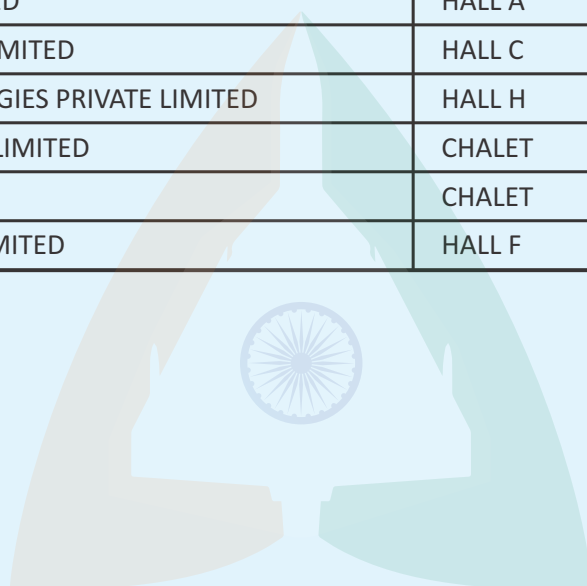

2023

# AERO INDIA

The Runway to a Billion Opportunities

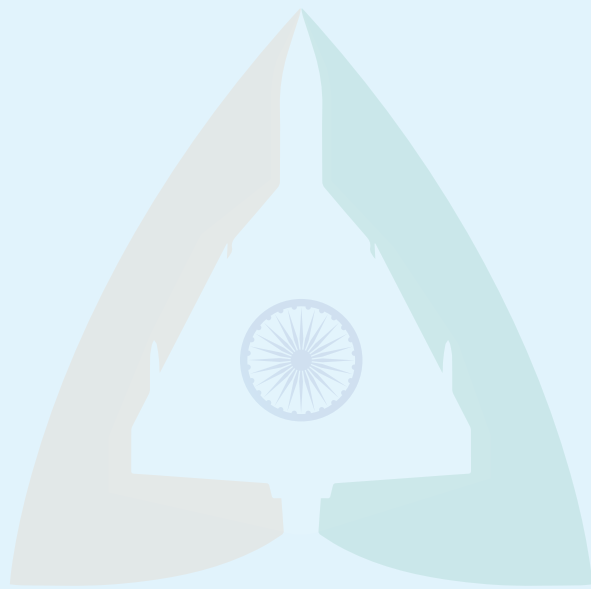

2023

# AERO INDIA

The Runway to a Billion Opportunities

Government of India  
Ministry of Defence



Department of  
Defence Production



75  
Azadi Ka  
Amrit Mahotsav



2023

**AERO INDIA**  
The Runway to a Billion Opportunities

# Hall-wise List of Exhibitors

# OUTDOOR DISPLAY

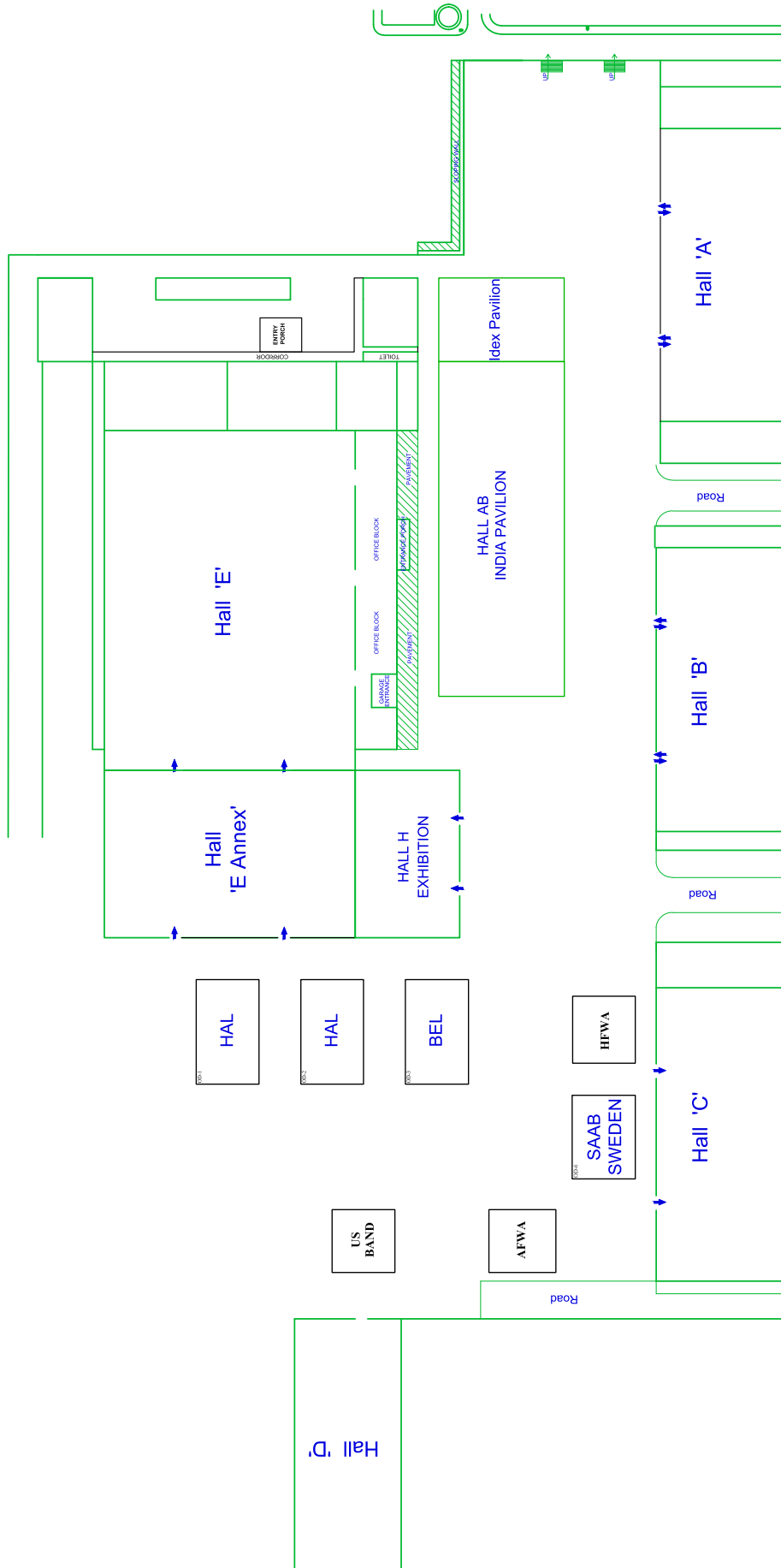





## OUTDOOR

EXHIBITOR	LOCATION
BHARAT ELECTRONICS LIMITED	OD.03
HINDUSTAN AERONAUTICS LIMITED	OD.01, 02
SAAB	OD.06

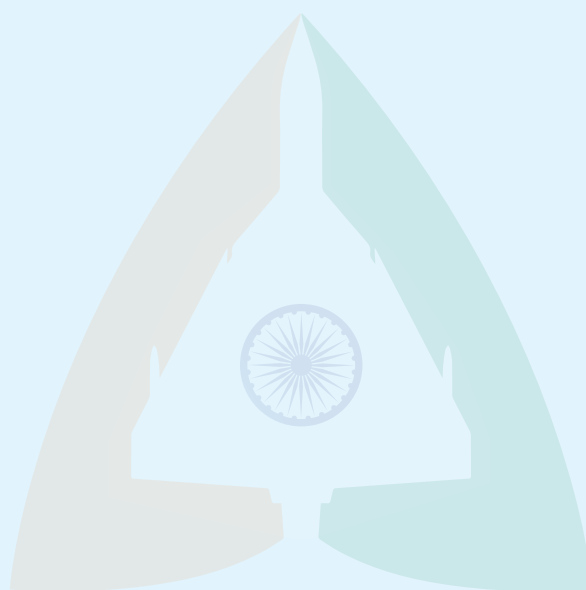

2023

# AERO INDIA

The Runway to a Billion Opportunities





## CHALET (SINGLE / DOUBLE STOREY)

EXHIBITOR	LOCATION
ARMY AVIATION	CHALET 19, 20
BHARAT ELECTRONICS LIMITED	CHALET 39, 40
BHARAT FORGE LIMITED	CHALET 35
DEFENCE RESEARCH AND DEVELOPMENT ORGANISATION	CHALET 25 - 28
MINISTRY OF DEFENCE	CHALET 01 - 08
DYNAMATIC TECHNOLOGIES LIMITED	CHALET 37
HARYANA GOVERNMENT	CHALET 38
HINDUSTAN AERONAUTICS LIMITED	CHALET 21 - 24
HEAD QUARTERS INTEGRATED DEFENCE STAFF	CHALET 11
INDIAN AIR FORCE	CHALET 13 - 16

EXHIBITOR	LOCATION
INDIAN NAVY	CHALET 17, 18
KALLMAN WORLDWIDE INC	CHALET 32
KARNATAKA UDYOG MITRA, GOVERNMENT OF KARNATAKA	CHALET 12
RAFALE INTERNATIONAL	CHALET 29, 30
ROLLS-ROYCE	CHALET 31
ROSOBORONEXPORT JSC	CHALET 33
UAC	CHALET 34
ZEALTEK ENTERPRISES PRIVATE LIMITED	CHALET 41
ZEN TECHNOLOGIES LIMITED	CHALET 36

2023

# AERO INDIA

The Runway to a Billion Opportunities

# HALL A



2023

**AERO INDIA**  
The Runway to a Billion Opportunities

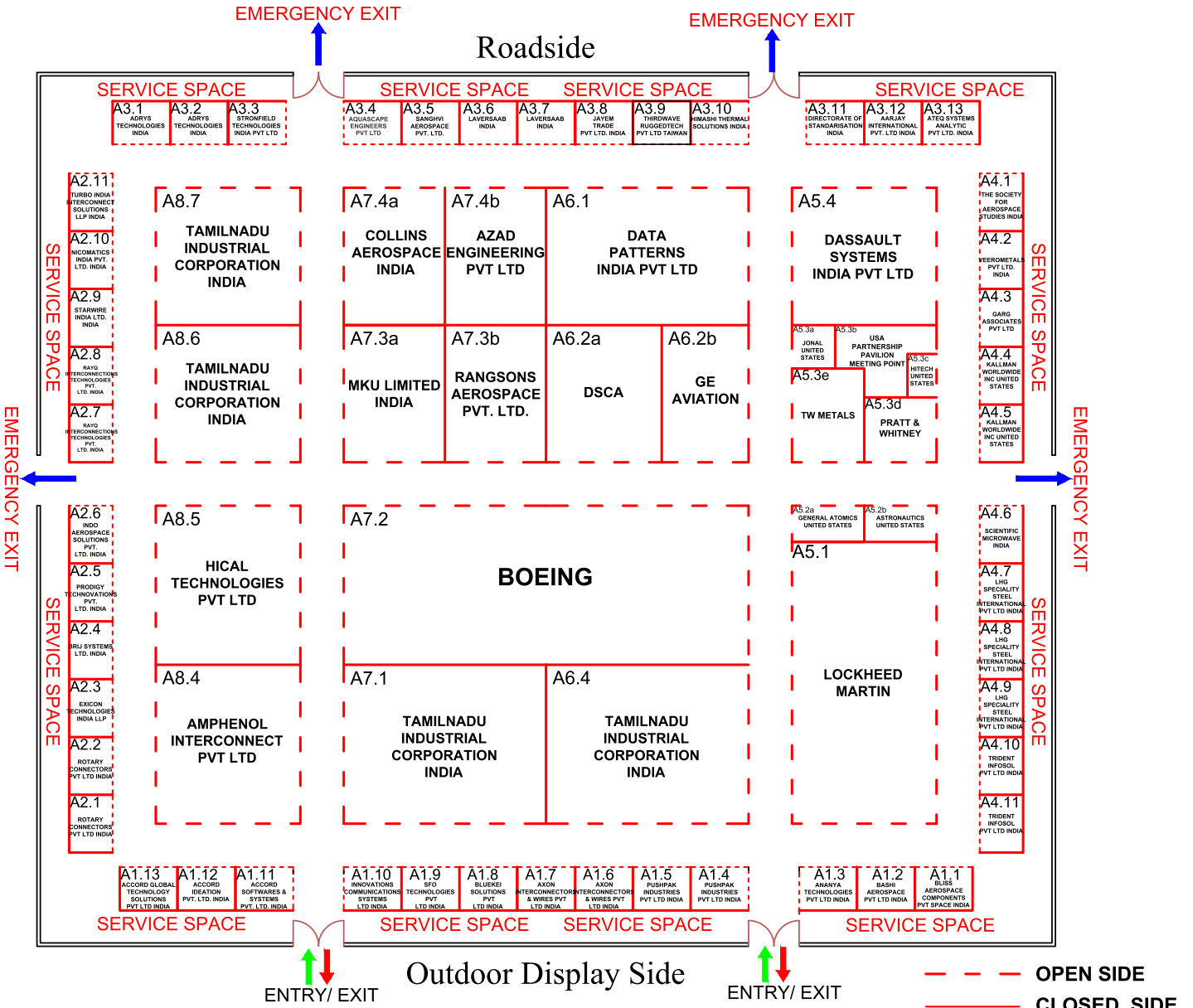



## HALL A

EXHIBITOR	LOCATION
AARJAY INTERNATIONAL PRIVATE LIMITED	A3.12
ACCORD GLOBAL TECHNOLOGY SOLUTIONS PRIVATE LIMITED	A1.13
ACCORD IDEATION PRIVATE LIMITED	A1.12
ACCORD SOFTWARE AND SYSTEMS PRIVATE LIMITED	A1.11
ADRY'S TECHNOLOGIES	A3.1, 3.2
AMPHENOL INTERCONNECT INDIA PRIVATE LIMITED	A8.4
ANANYA TECHNOLOGIES PRIVATE LIMITED	A1.3
AQUASCAPE ENGINEERS PRIVATE LIMITED	A3.4
ATEQ SYSTEMS ANALYTIC INDIA PRIVATE LIMITED	A3.13
AXON INTERCONNECTORS AND WIRES PRIVATE LIMITED	A1.7, A1.6
AZAD ENGINEERING PRIVATE LIMITED	A7.4b
BASHI AEROSPACE PRIVATE LIMITED	A1.2
BLISS AEROSPACE COMPONENTS PRIVATE LIMITED	A1.1
BLUEKEI SOLUTIONS PRIVATE LIMITED	A1.8
BRIJ SYSTEMS LIMITED	A2.4
COLLINS AEROSPACE	A7.4a
DASSAULT SYSTEMES INDIA PRIVATE LIMITED	A5.4
DATA PATTERNS (INDIA) LIMITED	A6.1
DIRECTORATE OF STANDARDISATION	A3.11
EXICOM TECHNOLOGIES INDIA LLP	A2.3
GARG ASSOCIATES PRIVATE LIMITED	A4.3
HICAL TECHNOLOGIES PRIVATE LIMITED	A8.5
HIMANSHI THERMAL SOLUTIONS	A3.10
INDO AEROSPACE SOLUTIONS PRIVATE LIMITED	A2.6
INNOVATION COMMUNICATIONS SYSTEMS LIMITED	A1.10
JAYEM TRADE PRIVATE LIMITED	A3.8

EXHIBITOR	LOCATION
KALLMAN WORLDWIDE INC	A4.4,4.5,5.1,
	5.2,5.3,6.3, 7.2
KWI	A6.2
LAVERSAB INDIA	A3.6, A3.7
LHG SPECIALITY STEEL INTERNATIONAL PRIVATE LIMITED	A4.7,4.8,4.9
MKU LIMITED	A7.3a
NICOMATIC INDIA ELECTRONICS PRIVATE LIMITED	A2.10
PRODIGY TECHNOVATIONS PRIVATE LIMITED	A2.5
PUSHPAK INDUSTRIAL SERVICES	A1.4
PUSHPAK PRODUCTS INDIA PRIVATE LIMITED	A1.5
RANGSONS AEROSPACE PRIVATE LIMITED	A7.3b
RAY-Q INTERCONNECTION TECHNOLOGIES INDIA PRIVATE LIMITED	A2.7, A2.8
ROTARY CONNECTORS PRIVATE LIMITED	A2.1
ROTARY ELECTRONICS PRIVATE LIMITED	A2.2
SANGHVI AEROSPACE PRIVATE LIMITED	A3.5
SCIENTIFIC MICROWAVE	A4.6
SFO TECHNOLOGIES PRIVATE LIMITED	A1.9
STAR WIRE INDIA LIMITED	A2.9
STRONGFIELD TECHNOLOGIES INDIA PRIVATE LIMITED	A3.3
TAMIL NADU INDUSTRIAL DEVELOPMENT CORPORATION	A6.4,7.1,8.6,8.7
THE SOCIETY FOR AEROSPACE STUDIES	A4.1
THIRD WAVE RUGGEDTECH PRIVATE LIMITED	A3.9
TRIDENT INFOSOL PRIVATE LIMITED	A4.10, A4.11
TURBO INDIA INTERCONNECT SOLUTIONS LLP	A2.11
VEER-O-METALS PRIVATE LIMITED	A4.2







## HALL B

EXHIBITOR	LOCATION
ACCIAIERIE VALBRUNA S.P.A	B5.27
ANKIT AEROSPACE PRIVATE LIMITED	B1.2
AVIAHELP	B5.3
AXISCADES TECHNOLOGIES LIMITED	B1.1
BEVEL GEARS (INDIA) PRIVATE LIMITED	B5.33
BIKAR AEROSPACE	B5.29,5.30
CAPTRONIC SYSTEMS PRIVATE LIMITED	B5.23
CARRIS PIPES AND TUBES PRIVATE LIMITED	B5.25
CINGULARITY TOOLING & ENGINEERING CONCEPTS	B5.4
INDIA PRIVATE LIMITED	
COMPUPOWER PRIVATE LIMITED	B5.20,5.21
CSIR NATIONAL AEROSPACE LABORATORIES	B3.3
DASSAULT AIRCRAFT SERVICES INDIA PRIVATE LIMITED	B2.1
DATASOL BANGALORE PRIVATE LIMITED	B5.32
DEEP ENGINEERING INDUSTRIES	B5.9
EMBRAER	B2.2b
FUTURE METALS LLC	B5.5
GIFAS	B3.2,4.1,4.2
GODREJ & BOYCE MANUFACTURING COMPANY LIMITED	B2.2c
HIND SALES CORPORATION	B5.8
HI-REL TECH PRIVATE LIMITED	B5.26
HYPERCOAT ENTERPRISES PRIVATE LIMITED	B5.17A
INVESTMENT & PRECISION CASTINGS LIMITED	B5.12

EXHIBITOR	LOCATION
MAINI MATERIALS MOVEMENT PRIVATE LIMITED	B4.3
MBDA	B3.1
MERLINHAWK AEROSPACE PRIVATE LIMITED	B1.3
METAL EXTRUSIONS	B5.16
NOBLE AEROSPACE PRIVATE LIMITED	B5.14
ORIENTAL WEAVING & PROCESSING MILLS PRIVATE LIMITED	B5.24
PAWAN HANS LIMITED	B5.17C
PBS INDIA PRIVATE LIMITED	B5.10, B5.11
REUTECH INDIA PRIVATE LIMITED	B5.28
ROSOBORONEXPORT JSC	B2.3
SAARC TOOL TECH PRIVATE LIMITED	B5.15
SANPAR MICROFILTERS PRIVATE LIMITED	B5.22
SCONCE GLOBAL PRIVATE LIMITED	B5.6, B5.7
SIKA INTERPLANT SYSTEMS LIMITED	B2.2a
SMPP PRIVATE LIMITED	B2.2d
SOFTEC SERVICES	B5.18
THE ACCESSORIES	B5.17B
THE BHOR CHEMICALS AND PLASTICS PRIVATE LIMITED	B5.1
TIMETOOTH TECHNOLOGIES PRIVATE LIMITED	B5.31
TRASCCON INTERCONNECTION SYSTEMS PRIVATE LIMITED	B5.13
UCAM PRIVATE LIMITED	B5.19
V V HITECH INNOVATIONS INDIA PRIVATE LIMITED	B5.17
VAR ELECTROCHEM PRIVATE LIMITED	B5.2

# HALL C



**AERO INDIA**  
The Runway to a Billion Opportunities

**EMERGENCY EXIT**  
↑

**EMERGENCY EXIT**  
↑

Roadside Side

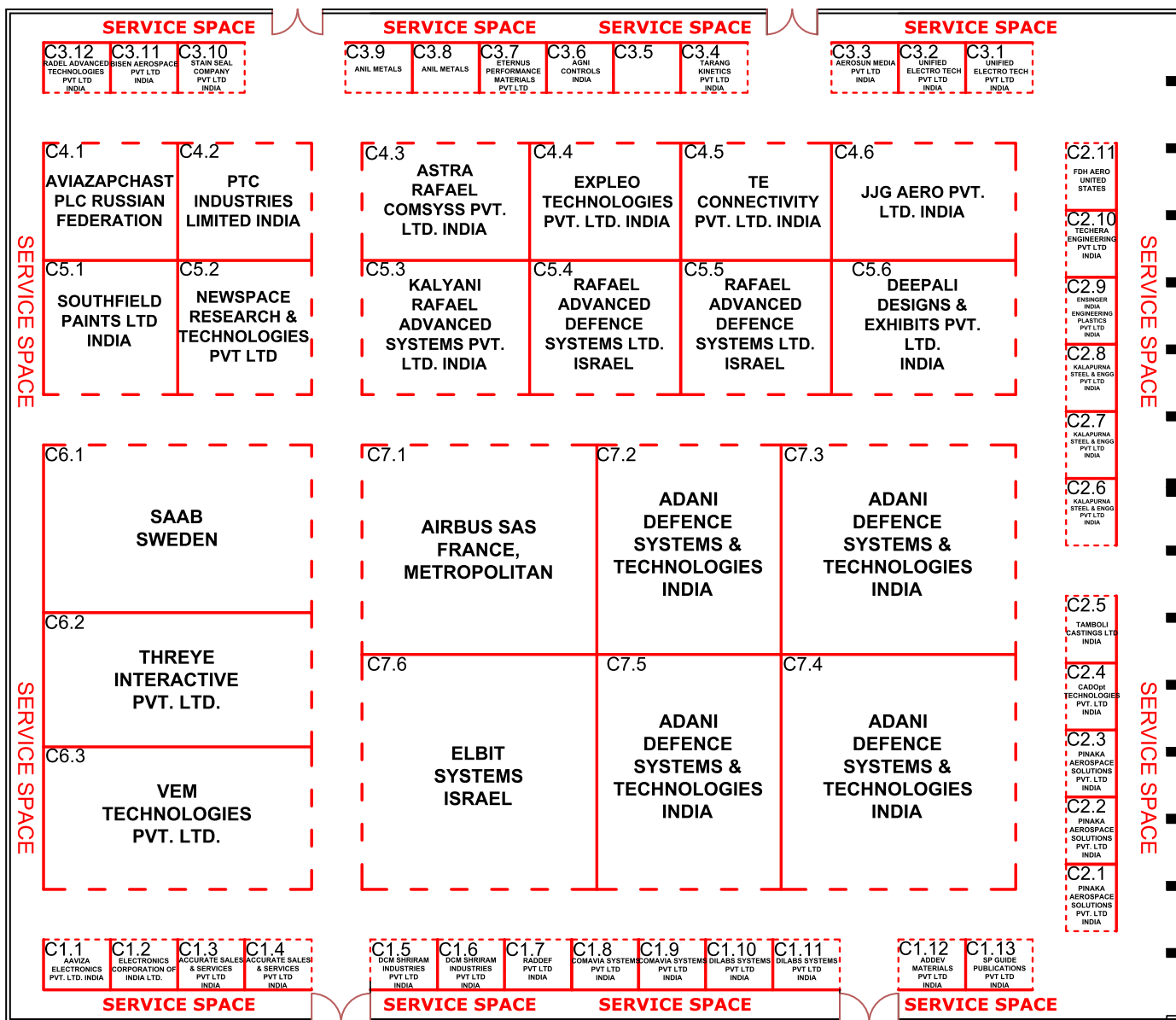

↑ ↓  
ENTRY/EXIT

Outdoor Display Side

↑ ↓  
ENTRY/EXIT



## HALL C

EXHIBITOR	LOCATION
ACCURATE SALES & SERVICES PRIVATE LIMITED	C1.3,1.4
AAVIZA ELECTRONICS PRIVATE LIMITED	C1.1
ADANI DEFENCE SYSTEMS AND TECHNOLOGIES LIMITED	C7.2,7.3,7.4,7.5
ADDEV MATERIALS PRIVATE LIMITED	C1.12
AEROSUN MEDIA PRIVATE LIMITED	C3.3
AGNI CONTROLS	C3.6
AIRBUS SAS	C7.1
ANIL METALS & ALLOYS PRIVATE LIMITED	C3.8,3.9
ASTRA RAFAEL COMSYS PRIVATE LIMITED	C4.3
AVIAZAPCHAST PLC	C4.1
BISEN AEROSPACE PRIVATE LIMITED	C3.11
CADOPTTECHNOLOGIES PRIVATE LIMITED	C2.4
COMAVIA SYSTEMS TECHNOLOGIES PRIVATE LIMITED	C1.8,1.9
DCM SHRIRAM INDUSTRIES LIMITED	C1.5, C1.6
DEEPALI DESIGNS AND EXHIBITS PRIVATE LIMITED	C5.6
DILABS SYSTEMS PRIVATE LIMITED	C1.10,1.11
ELBIT SYSTEMS	C7.6
ELECTRONICS CORPORATION OF INDIA LIMITED	C1.2
ENSINGER INDIA ENGINEERING PLASTICS PRIVATE LIMITED	C2.9
ETERNUS PERFORMANCE MATERIALS PRIVATE LIMITED	C3.7
EXPLEO TECHNOLOGIES INDIA PRIVATE LIMITED	C4.4

EXHIBITOR	LOCATION
FDH AERO	C2.11
JJG AERO PRIVATE LIMITED	C4.6
KALAPURNA STEEL & ENGG PRIVATE LIMITED	C2.6,2.7,2.8
KALYANI RAFAEL ADVANCED SYSTEMS PRIVATE LIMITED	C5.3
NEWSPACE RESEARCH AND TECHNOLOGIES PRIVATE LIMITED	C5.2
PINAKA AEROSPACE SOLUTIONS PRIVATE LIMITED	C2.1,2.2,2.3
PTC INDUSTRIES LIMITED	C4.2
RADDEF PRIVATE LIMITED	C1.7
RADEL ADVANCED TECHNOLOGY PRIVATE LIMITED	C3.12
RAFAEL ADVANCED TECHNOLOGY PRIVATE LIMITED	C5.4, C5.5
SAAB	C6.1
SOUTHFIELD PAINTS LIMITED	C5.1
SP GUIDE PUBLICATIONS PRIVATE LIMITED	C1.13
STEIN SEAL COMPANY INDIA PRIVATE LIMITED	C3.10
TAMBOLI CASTINGS LIMITED	C2.5
TARANG KINETICS PRIVATE LIMITED	C3.4
TE CONNECTIVITY INDIA PRIVATE LIMITED	C4.5
TECHERA ENGINEERING (INDIA) PRIVATE LIMITED	C2.10
THREYE INTERACTIVE PRIVATE LIMITED	C6.2
UNIFIED ELECTRO TECH PRIVATE LIMITED	C3.1, C3.2
VEM TECHNOLOGIES PRIVATE LIMITED	C6.3

The Runway to a Billion Opportunities

# HALL D

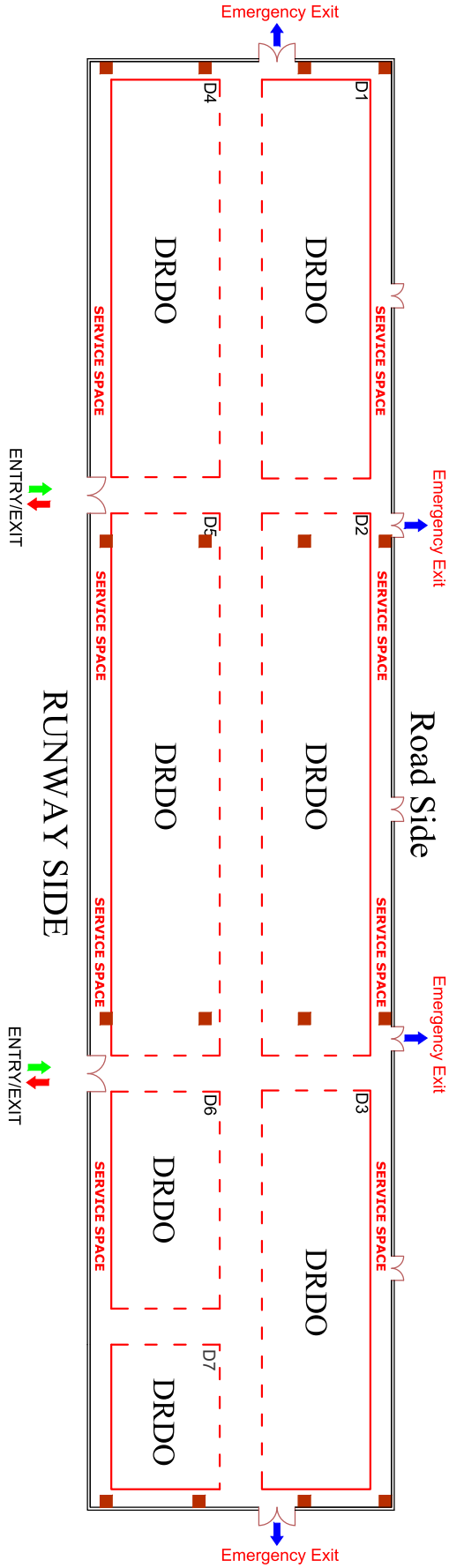





## HALL D

EXHIBITORY	LOCATION
DEFENCE RESEARCH AND DEVELOPMENT ORGANISATION	D1 - D7

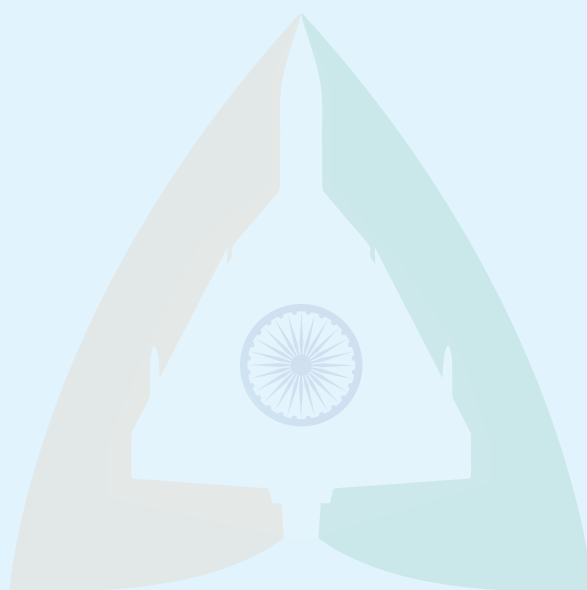

2023

# AERO INDIA

The Runway to a Billion Opportunities

# HALL E

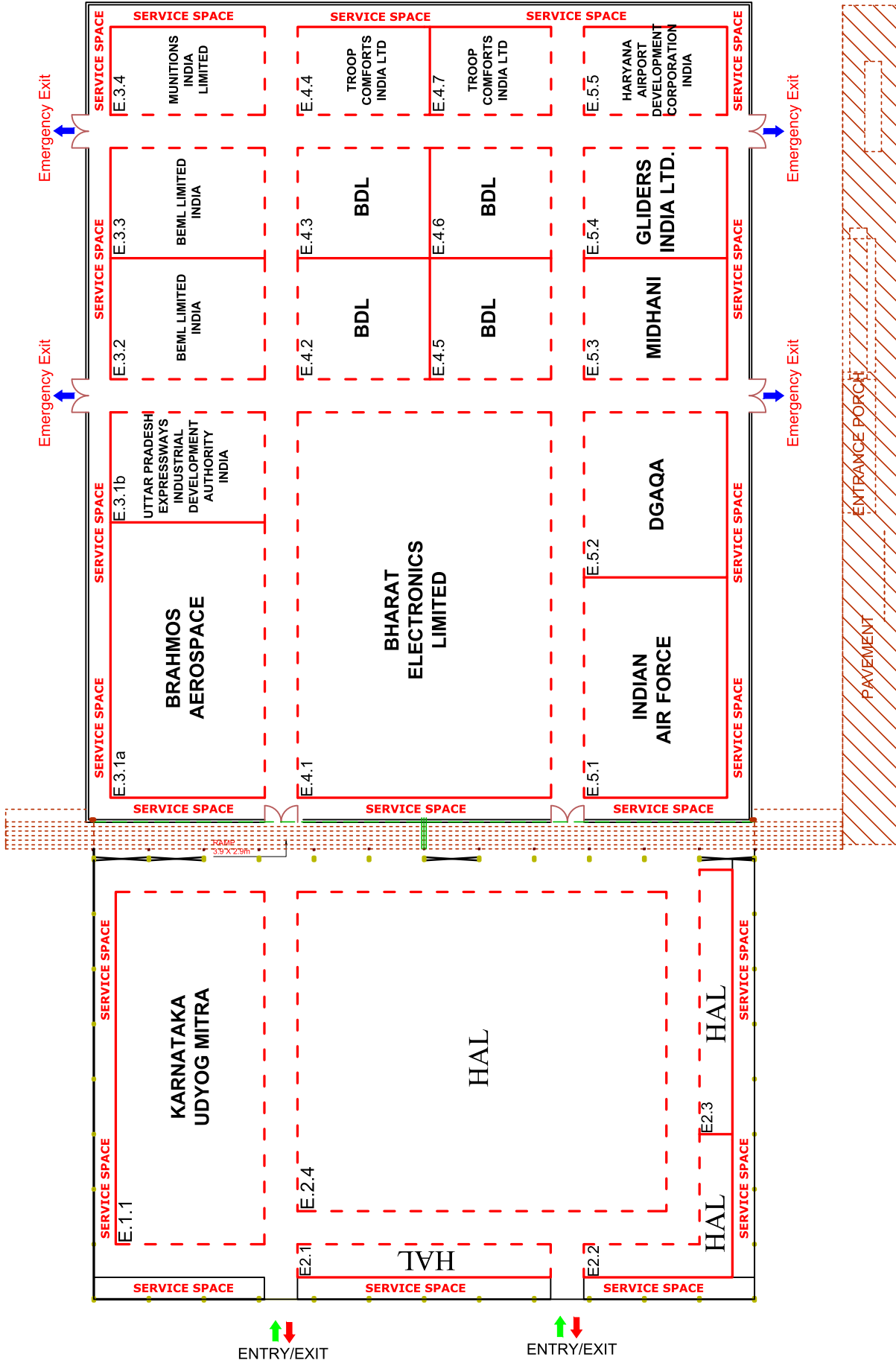



## HALL E

EXHIBITOR	LOCATION
BEML LIMITED	E.3.2, E.3.3
BHARAT DYNAMICS LIMITED	E.4.2,4.3,4.5,4.6
BHARAT ELECTRONICS LIMITED	E.4.1
BRAHMOS AEROSPACE	E.3.1A
DIRECTORATE GENERAL OF AERONAUTICAL QUALITY ASSURANCE	E.5.2
GLIDERS INDIA LIMITED	E.5.4
HARYANA AIRPORT DEVELOPMENT CORPORATION	E5.5
HINDUSTAN AERONAUTICS LIMITED	E.2.1 - 2.4

EXHIBITOR	LOCATION
INDIAN AIR FORCE	E.5.1
KARNATAKA UDYOG MITRA, GOVERNMENT OF KARNATAKA	E.1.1
MISHRA DHATU NIGAM LIMITED	E.5.3
MUNITIONS INDIA LIMITED	E.3.4
TROOP COMFORTS LIMITED	E.4.4, E.4.7
UTTAR PRADESH EXPRESSWAYS INDUSTRIAL DEVELOPMENT AUTHORITY	E.3.1B

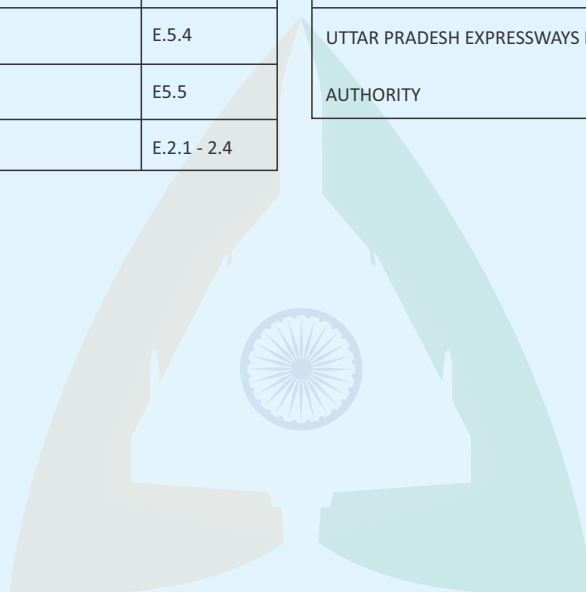

2023

# AERO INDIA

The Runway to a Billion Opportunities





## HALL F

EXHIBITOR	LOCATION
ACUTRONIC INDIA PRIVATE LIMITED	F1.6
AERO REL SYSTEMS PRIVATE LIMITED	F2.2
AMADO TOOLS	F3.14
AMI METALS UK LIMITED	F4.6,4.7
APEXPLUS TECHNOLOGIES PRIVATE LIMITED INDIA	F1.7
APOLLO AEROSPACE COMPONENTS INDIA PRIVATE LIMITED	F2.7
APOLLO MICRO SYSTEMS LIMITED	F5.7,5.8
ASTRA MICROWAVE PRODUCTS LIMITED	F6.1,6.2
AVDEL (INDIA) PRIVATE LIMITED	F1.9,1.10
AZISTA INDUSTRIES PRIVATE LIMITED	F6.5
BOLLHOFF FASTENINGS PRIVATE LIMITED	F1.5
COMPROTECH ENGINEERING PRIVATE LIMITED	F4.3
CONNEKT ELECTRONICS PRIVATE LIMITED	F2.3,2.4
DR MGR EDUCATIONAL AND RESEARCH INSTITUTE	F3.2
EATON INDUSTRIAL PRODUCT PRIVATE LIMITED	F5.4
ELECTRONIC DIMENSIONS	F1.14
ELETTRONICA SPA	F5.5
FABHEADS AUTOMATION PRIVATE LIMITED	F3.10
FORCE NEWS MAGAZINE	F3.5
FLIGHT SIMULATION TECHNIQUE CENTRE	F3.7, F3.8
GOPALAN AEROSPACE INDIA PRIVATE LIMITED	F6.3
HC ROBOTICS	F3.1
HINDUSTAN INSTITUTE OF TECHNOLOGY AND SCIENCE	F4.1
INDO-GERMAN CHAMBER OF COMMERCE	F5.6, F6.6

EXHIBITOR	LOCATION
INTEGRAL SYSTEMS AND COMPONENTS PRIVATE LIMITED	F1.11
ISRAEL AEROSPACE INDUSTRIES LIMITED	F5.1, 5.2
JAS PROPAC INC	F2.5
JISNU COMMUNICATIONS PRIVATE LIMITED	F2.6
KAPASI-SOUTHCO, INDIA	F4.5
KINGSLY INSTRUMENTATION & COMMUNICATION PRIVATE LIMITED	F1.1
LEGEND TECHNOLOGIES INDIA PRIVATE LIMITED	F2.1
LEONARDO	F6.7
MRF LIMITED	F6.8
NASMYTH ASIA (INDIA) PRIVATE LIMITED	F1.2
NEXT DEFENCE PRIVATE LIMITED	F4.4
NIVOX TECHNOLOGIES	F3.9
NUCON AEROSPACE PRIVATE LIMITED	F3.13
NUCON ALKAN AEROSPACE PRIVATE LIMITED	F3.11
NUCON PNEUMATICS PRIVATE LIMITED	F3.12
PARAS WIRES PRIVATE LIMITED	F3.4
RADIALL INDIA PRIVATE LIMITED	F1.8
SKANDA AEROSPACE TECHNOLOGY PRIVATE LIMITED	F4.2
SOUTHERN ELECTRONICS (BANGALORE) PRIVATE LIMITED	F1.13
SUMAN CONTROLS PRIVATE LIMITED	F1.12
THERMOVAC AEROSPACE PRIVATE LIMITED	F3.6
TRENTAR PRIVATE LIMITED	F5.3
ZEPHYR AEROSPACE PRIVATE LIMITED	F3.3



# HALL G

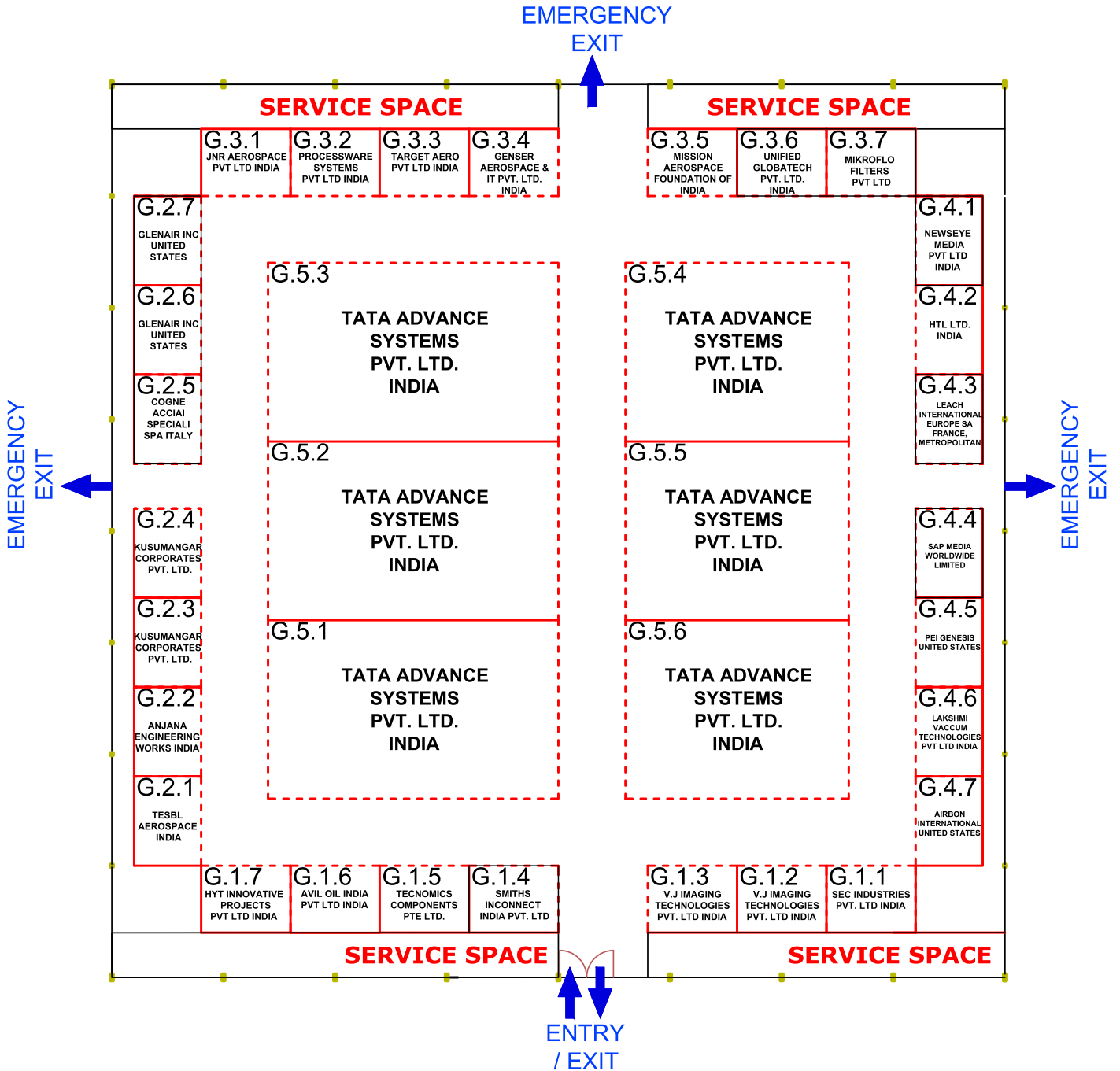

## HALL G

EXHIBITOR	LOCATION
AIRBORN INTERNATIONAL	G4.7
ANJANA ENGINEERING WORKS	G2.2
AVI-OIL INDIA PRIVATE LIMITED	G1.6
COGNE ACCIAI SPECIALI SPA	G2.5
GENSER AEROSPACE & IT PRIVATE LIMITED	G3.4
GLENAIR INC	G2.7,2.6
HTL LIMITED	G4.2
HYT INNOVATIVE PROJECTS PRIVATE LIMITED	G1.7
JNR AEROSPACE INDIA PRIVATE LIMITED	G3.1
KUSUMGAR CORPORATES PRIVATE LIMITED	G2.3,2.4
LAKSHMI VACUUM TECHNOLOGIES PRIVATE LIMITED	G4.6
LEACH INTERNATIONAL EUROPE SAS	G4.3
MIKROFLO FILTERS PRIVATE LIMITED	G3.7

EXHIBITOR	LOCATION
MISSION AEROSPACE FOUNDATION OF INDIA	G3.5
NEWSEYE MEDIA PRIVATE LIMITED	G4.1
PEI-GENESIS	G4.5
PROCESSWARE SYSTEMS PRIVATE LIMITED	G3.2
SAP MEDIA WORLDWIDE LIMITED	G4.4
SEC INDUSTRIES PRIVATE LIMITED	G1.1
SMITHS INTERCONNECT INDIA PRIVATE LIMITED	G1.4
TARGET AERO PRIVATE LIMITED	G3.3
TATA ADVANCED SYSTEMS LIMITED	G5.1 - 5.6
TECNOMIC COMPONENTS PRIVATE LIMITED	G1.5
TESBL AEROSPACE	G2.1
UNIFIED GLOBALTECH (I) PRIVATE LIMITED	G3.6
V J IMAGING TECHNOLOGIES PRIVATE LIMITED	G1.2,1.3

2023

# AERO INDIA

The Runway to a Billion Opportunities

# HALL H

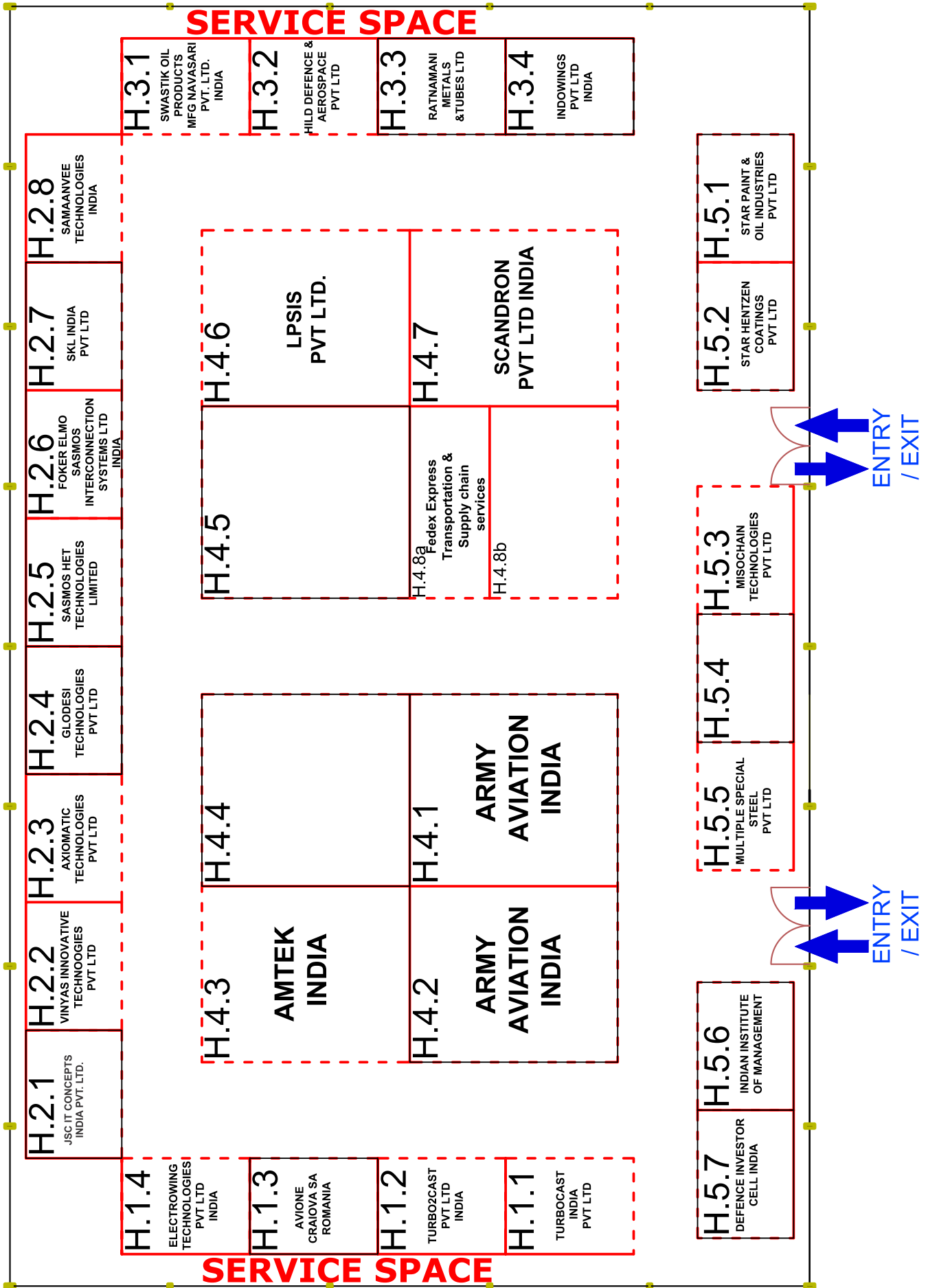



## HALL H

EXHIBITOR	LOCATION
AMETEK INDIA	H4.3
ARMY AVIATION	H4.1, H4.2
AVIOANE CRAIOVA S.A.	H1.3
AXIOMATIC ITECH PRIVATE LIMITED	H2.3
DEFENCE INVESTOR CELL	H5.7
ELECTROWING TECHNOLOGIES PRIVATE LIMITED	H1.4
FEDEX EXPRESS TRANSPORTATION & SUPPLY CHAIN SERVICES (INDIA) PRIVATE LIMITED	H4.8a
FOKKER ELMO SASMOS INTERCONNECTION SYSTEMS LIMITED	H2.6
GLODESI TECHNOLOGIES PRIVATE LIMITED	H2.4
HILD DEFENCE AND AEROSPACE PRIVATE LIMITED	H3.2
INDIAN INSTITUTE OF MANAGEMENT BANGALORE (IIMB)	H5.6
INDO WINGS PRIVATE LIMITED	H3.4
JSC IT CONCEPTS INDIA PRIVATE LIMITED	H2.1

EXHIBITOR	LOCATION
LPSIS PRIVATE LIMITED	H4.6
MISOCHAIN TECHNOLOGIES PRIVATE LIMITED	H5.3
MULTIPLE SPECIAL STEEL PRIVATE LIMITED	H5.5
RATNAMANI METALS AND TUBES LIMITED	H3.3
SAMANVEE TECHNOLOGIES	H2.8
SASMOS HET TECHNOLOGIES LIMITED	H2.5
SCANDRON PRIVATE LIMITED	H4.7
SKL INDIA PRIVATE LIMITED	H2.7
STAR HENTZEN COATINGS PRIVATE LIMITED	H5.2
STAR PAINT & OIL INDUSTRIES	H5.1
SWASTIK OIL PRODUCTS MFG NAVSARI PRIVATE LIMITED	H3.1
TURBO CAST INDIA PRIVATE LIMITED	H1.1
TURBO2 CAST PRIVATE LIMITED	H1.2
VINYAS INNOVATIVE TECHNOLOGIES PRIVATE LIMITED	H2.2

2023

# AERO INDIA

The Runway to a Billion Opportunities



Government of India  
Ministry of Defence



Department of  
Defence Production



75  
Azadi Ka  
Amrit Mahotsav



2023

**AERO INDIA**  
The Runway to a Billion Opportunities

# India Pavilion

# INDIA PAVILION



2023

**AERO INDIA**  
The Runway to a Billion Opportunities

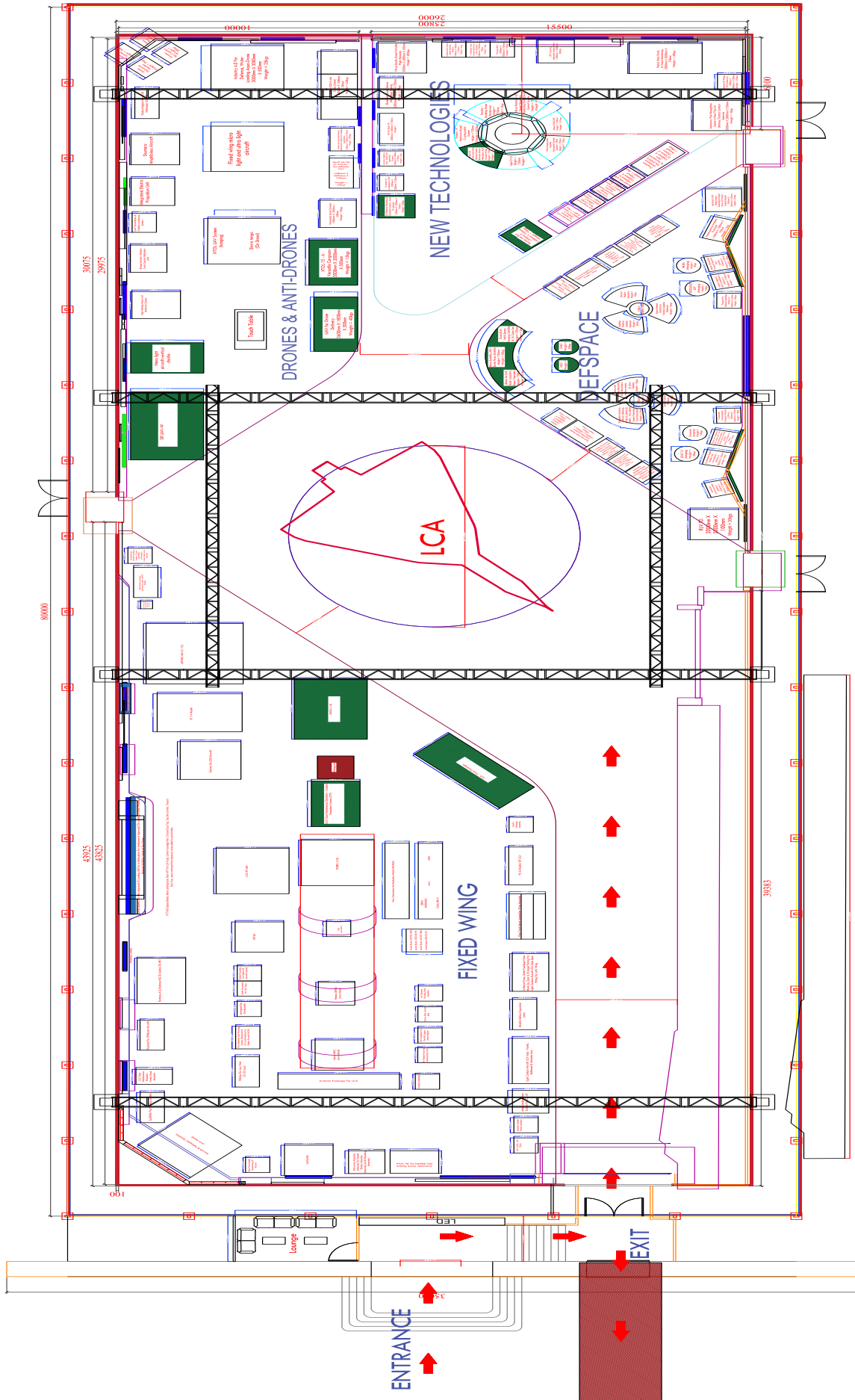

EXHIBITOR
ABSOLUTE COMPOSITES PRIVATE LIMITED
ABYOM SPACETECH & DEFENCE PRIVATE LIMITED
ACCURATE INDUSTRIAL CONTROLS PRIVATE LIMITED
ADANI DEFENCE SYSTEMS & TECHNOLOGIES LTD
ADITYA PRECITECH PRIVATE LIMITED
AERON SYSTEMS PRIVATE LIMITED
AEROSYS AVIATION INDIA PRIVATE LIMITED
AGNIKUL COSMOS PRIVATE LIMITED
AICLOUDS AERO LLP
AIDIN TECHNOLOGIES PRIVATE LIMITED
AIKAIROS PRIVATE LIMITED
AKSHATH AEROSPACE PRIVATE LIMITED
ALBATROSS FLYING SYSTEMS OPC PRIVATE LIMITED
ALTZ TECHNOLOGIES PRIVATE LIMITED
ASTR DEFENCE PRIVATE LIMITED
ASTRA MICROWAVE PRODUCTS LIMITED
ASTROGATE LABS
ASTROMEDA SPACE PRIVATE LIMITED
AUTOMICRO UAS AEROTECH OPC PRIVATE LIMITED
AYAAN AUTONOMOUS SYSTEMS PRIVATE LIMITED
AZISTA-BST AEROSPACE PRIVATE LIMITED
BALA ASTRAL SOLUTIONS PRIVATE LIMITED
BHARAT DYNAMICS LIMITED
BHARAT ELECTRONICS LIMITED
BHARAT FORGE LIMITED
BHARAT FORGE LIMITED
BIG BANG BOOM SOLUTIONS
BIGBANGBOOM SOLUTIONS
BRAHMOS AEROSPACE
BRISK OLIVE BUSINESS SOLUTIONS PRIVATE LIMITED
DEFENCE RESEARCH AND DEVELOPMENT ORGANISATION
CENTRE FOR DEVELOPMENT OF TELEMATICS
CHIPSPIRIT TECHNOLOGIES PRIVATE LIMITED

EXHIBITOR
CINGULARITY TOOLING & ENGINEERING CONCEPTS INDIA PRIVATE LIMITED
COLLABORATIVE INTELLIGENCE PRIVATE LIMITED
COREIOT TECHNOLOGIES
CSIR NATIONAL AEROSPACE LABORATORIES
DELOITTE
DELOPT - A JK ORGANISATION
DFY GRAVITI TECHNOLOGIES PRIVATE LIMITED
DHRUVA SPACE PRIVATE LIMITED
DIGANTARA RESEARCH & TECHNOLOGIES PRIVATE LIMITED
DRDO - AERONAUTICAL DEVELOPMENT ESTABLISHMENT
DRDO - AERONAUTICAL DEVELOPMENT AGENCY
DVIZIRA
DYNAMATIC TECHNOLOGIES LIMITED
EC BLADES & TOOLS PRIVATE LIMITED
EON SPACE LABS PRIVATE LIMITED
GALAXEYE SPACE
GARUDAN UNMANNED SYSTEM PRIVATE LIMITED
GLIDERS INDIA LIMITED
GTN ENGINEERING INDIA LIMITED
GURUTVAA SYSTEMS PRIVATE LIMITED
HINDUSTAN AERONAUTICS LIMITED
HC ROBOTICS PRIVATE LIMITED
INDIAN AIR FORCE
IDEAFORGE TECHNOLOGY PRIVATE LIMITED
IIT KANPUR-STARTUP INCUBATION & INNOVATION CENTRE
INDIAN ARMY
INDIAN INSTITUTE OF SCIENCE
INFERIGENCE QUOTIENT PRIVATE LIMITED
INFINITY ARSENAL PRIVATE LIMITED
INN-FORCE TECHNOLOGIES PRIVATE LIMITED
INNOVATION COMMUNICATIONS SYSTEMS LIMITED
INVICTUS DEFENCE SYSTEMS PRIVATE LIMITED
INDIAN SPACE RESEARCH ORGANISATION



EXHIBITOR
JATAYU UNMANNED SYSTEMS
KADET DEFENCE SYSTEMS PRIVATE LIMITED
KEPLER AEROSPACE PRIVATE LIMITED
KITEMAPS AMS PRIVATE LIMITED (REDWING LABS)
LAKSHMI MACHINE WORKS LIMITED
LAKSHYA FLYING SYSTEMS
LARSEN & TOUBRO
LEKHA WIRELESS SOLUTIONS PRIVATE LIMITED
LOGIC FRUIT TECHNOLOGIES
LYLE TECHNOLOGIES LLP
MANASTU SPACE TECHNOLOGIES PRIVATE LIMITED
MERLINHAWK AEROSPACE PRIVATE LIMITED
METALLIC BELLOWS INDIA PRIVATE LIMITED
MISHRA DHATU NIGAM LIMITED
MODEL AVIATION
MODEL AVIATION & HELICAM INDIA
MULTI TECK ENGINEERING SOLUTIONS
MUNITIONS INDIA LIMITED
NATIONAL AEROSPACE LABORATORIES
NAVYUG INFOSOLUTIONS PRIVATE LIMITED
NAYAN INDIA SCIENCE & TECHNOLOGIES PRIVATE LIMITED
NORTH STREET COOLING TOWER PRIVATE LIMITED
NW ENGINEERING PRIVATE LIMITED
OKULO AEROSPACE PRIVATE LIMITED
ONEWEB
OXYGEN 2 INNOVATION PRIVATE LIMITED
PARACHUTE TECHNOLOGIES PRIVATE LIMITED
PARALLAX LABS
PARETO TREE PRIVATE LIMITED
PINAKA AEROSPACE SOLUTIONS PRIVATE LIMITED
PIXCEL
PUPILMESH PRIVATE LIMITED
PVM INNSENSYS PRIVATE LIMITED

EXHIBITOR
QED ANALYTICALS LLP
QUNU LABS PRIVATE LIMITED
RANGEAERO PRIVATE LIMITED
RANGSONS AEROSPACE PRIVATE LIMITED
RF NANO COMPOSITES PRIVATE LIMITED
ROSPACE AEROTECH PRIVATE LIMITED
SAGAR DEFENCE ENGINEERING PRIVATE LIMITED
SATSURE ANALYTICS INDIA PRIVATE LIMITED
SKYROOT AEROSPACE PRIVATE LIMITED
SOUTHERN ELECTRONICS PRIVATE LIMITED
SPACEFIELDS PRIVATE LIMITED
SPACEKAWA EXPLORATIONS PRIVATE LIMITED (KAWA SPACE)
SPACEMAN CRAFT (OPC) PRIVATE LIMITED
SPANTRIK PRIVATE LIMITED
STRAVA TECHNOLOGIES PRIVATE LIMITED
SURYUDEY PLASTIC ELECTRONICS PRIVATE LIMITED
TATA ADVANCED SYSTEMS LIMITED
TATA AEROSPACE & DEFENCE
TE CONNECTIVITY INDIA PRIVATE LIMITED
TEAM-D ENGINEERING PRIVATE LIMITED
TROOP COMFORTS LIMITED
TSALLA AEROSPACE TECHNOLOGIES PRIVATE LIMITED
TSC TECHNOLOGIES PRIVATE LIMITED
UCAM PRIVATE LIMITED
VASUNDHARAA GEO TECHNOLOGIES PRIVATE LIMITED
VELLON SPACE PRIVATE LIMITED
VEM TECHNOLOGIES PRIVATE LIMITED
VIZEXPERTS INDIA PRIVATE LIMITED
XOVIAN AEROSPACE PRIVATE LIMITED
ZEUS NUMERIX PRIVATE LIMITED

Government of India  
Ministry of Defence



Department of  
Defence Production



75  
Azadi Ka  
Amrit Mahotsav



2023

**AERO INDIA**  
The Runway to a Billion Opportunities

# Exhibitors Details



2023

# AERO INDIA

The Runway to a Billion Opportunities

Hall No. : Hall A  
Stall No. : A3.12

### AARJAY INTERNATIONAL PRIVATE LIMITED

Name : JAYRAM R  
Phone : 9962491675  
Email : jayagopan@aarjay.com  
Website : www.aarjay.com  
Contact Person Name : JAYA GOPAN G V

#### Profile

Aarjay International Pvt Ltd is a single source for a wide range of testing & automation solutions. Aarjay brings you standard and proven solutions from global leaders of testing products such as Tektronix, Hioki, ITech, Fluke, Powerside and more. Aarjay supports Make-in-India by developing customized solutions which combine the in-house expertise of our engineers and the unique technologies offered by our OEM partners. Our offerings include electronics test & measurement solutions, radar & GNSS simulators, avionics testing products, automated test equipment (ATEs), factory process automation and condition monitoring solutions. Aarjay has expertise in test application development (C/C++, Python, LabVIEW), PLC-based automation solutions, SCADA systems, data acquisition systems and pneumatic systems. Aarjay serves customers in Aerospace, Defence, Automotive and Industrial sectors. Aarjay is an ISO9001:2015 certified company and is a registered MSME.

Hall No. : Hall C  
Stall No. : C1.1

### AAVIZA ELECTRONICS PRIVATE LIMITED

Name : Charles Raj Gattu  
Phone : 09000507340  
Email : charles.g@aaviza.com  
Website : www.aaviza.com  
Contact Person Name : Charles Raj Gattu

#### Profile

We are primarily an EMS company with focus on Wire Harnessing, Electromechanical assembly, Product assembly, Coil assembly and PCBA. Our services include Harness design, Product development, Overbraiding and Site installation. We cater to Aerospace and Defence, Industrial, Automotive, Railway, Medical, IT Enabled product and Consumer Electronics markets. We have 2 State of the Art manufacturing facilities spread across 30,000+ sq ft located strategically at Bangalore and Coimbatore. Our certifications include AS9100 Rev D, IATF 16949, ISO 13485, ISO 9001:2015. Our facility is also certified for UL ZPFW2.

Hall No. : Hall B  
Stall No. : B5.27

### ACCIAIERIE VALBRUNA S.P.A

Name : Nadeem Hussain  
Phone : +39 0471 924111  
Email : nadeem@valbrunaindia.com  
Website : www.valbruna-stainless-steel.com  
Contact Person Name : Snehal Patil

#### Profile

We are an Italian Group manufacturing Stainless Steel & Nickel Alloy Long products in 600 different grade category. Our profiles include Rolled products(round/square/hex/flat/angles – sizes 03mm to 600mm), Billet/Bloom, Ingots, etc. Stainless Steel: 300/400 series, PH/Nitronic/Duplex/Super Duplex Steels, etc. Nickel Alloy: Alloy 20/80A/C276/400/500/660/625/825/904/925/926, etc. Valbruna supplies material to clients in various sectors. A few being: •Power Generation: Siemens , Alstom, GE, etc. •Aerospace: Alenia , Bombardier , LSI etc. •Automotive: Bosch, Magnetti Marelli, Eaton, etc. •Oil & Gas : Grundfos, KSB, Flowserve, Emerson, etc.

Hall No. : Hall A  
Stall No. : A1.13

### ACCORD GLOBAL TECHNOLOGY SOLUTIONS PRIVATE LIMITED

Name : Jaydeep Kanetkar  
Phone : 9945242991  
Email : jaydeep@accord-soft.com  
Website : https://www.accord-global.com/  
Contact Person Name : Jaydeep Kanetkar

#### Profile

Accord Global Technology Solutions Private Limited (AGTSPL) is part of the Accord Group of Companies with primary focus on Aerospace, Automotive and Digital Technology Enterprise Products and Engineering Services. AGSPL has carved for itself a niche in the fields of: - Build-to-Spec Avionics-LRUs and GNSS-for-Aerospace products-Software Engineering Services for Avionics, Automotive, Desktop and Mobile Applications-System Engineering Services with expertise in RF, FPGA and ASIC engineering. -Automated Test Equipment development and Environmental Qualification. Over the years, Accord Group has chartered an impressive record of accomplishment in customer Satisfaction, Innovation, Sales, and Profitability. Avionics systems designed and developed by AGTSPL are flying in more than 20,000 aircrafts. AGTSPL has participated in prestigious International Aircraft Programs such as, Airbus A380, A400M, A350, Boeing 787 Dreamliner, MRJ, Embraer KC-390, Gulfstream G650/VII, India's LCA/Tejas, H-135, Sikorsky S-76, NH-90, MD-500/900, HAL's LUH, LCH Rotorcraft and Rustom I & II UAVs.

Hall No. : Hall A  
Stall No. : A1.12

### ACCORD IDEATION PRIVATE LIMITED

Name : Bharathi Dhasan  
Phone : 9740449911  
Email : idbd@accord-soft.com  
Website : www.accord-soft.com  
Contact Person Name : Bharathi Dhasan

#### Profile

We are the trusted Accord brand, with more than 26 years of accomplishments in technology development and Engineering, in the Navigation and Avionics industry segments.

Hall No. : Hall A  
Stall No. : A1.11

### ACCORD SOFTWARE AND SYSTEMS PRIVATE LIMITED

Name : Jitendra Sethi  
Phone : 8105045959  
Email : praveena.k@accord-soft.com  
Website : www.accord-soft.com  
Contact Person Name : Jitendra Sethi

#### Profile

Accord Software & Systems Pvt. Ltd. (ASSPL) was established at Bangalore, India in 1991 by five technologists who have worked in the field of avionics and real time embedded systems over several decades. ASSPL has carved for itself a niche in the fields of: Global Navigation Satellite System (GNSS) Receiver. GNSS ECM System. -GNSS Time Servers. -GNSS Simulator. CDMA Transceivers. ASSPL has invested in Semiconductor chipset solutions to develop GNSS receivers. It has a strong research and development team working on GNSS receiver technology providing Indigenous Designed, Developed and Manufactured (IDDM) GNSS products for Indian Defence, Aviation and Commercial applications. Some of the major accomplishments for ASSPL in GNSS domain and related technologies include: -GNSS based Time Server for Indian Navy, IAF, Indian Army DRDO, PSU and ISRO. -High Dynamics GNSS receivers for various strategic applications. -GNSS receivers for Tanks, Artillery Guns, and Aircrafts to various global players.

Hall No. : Hall C  
Stall No. : C1.3,C1.4

### ACCURATE SALES & SERVICES PRIVATE LIMITED

Name : SURESH PATIL  
Phone : 9970098403  
Email : svpatil@accurategauging.com  
Website : www accuratesales.co.in  
Contact Person Name : SURESH PATIL

#### Profile

Accurate Sales and Services Pvt Ltd is a leader in providing the best 3D measurement Products like 3D CMM, 3D Scanners Auto gauging Station and software for metrology data capturing and analysis software's and autonomous technologies. The company provides Third Party Inspection (Quality Engineering) Services and Quality 4.0 solutions to the Engineering Industry. The Company is ISO 9001: 2015 and ISO/IEC 17020:2012 certified company with registered vendor in Government sector in Indian Railways, Ordnance Factories, HAL and DRDO. The company has a wide network of Sales and Service workforce located throughout the country.

Hall No. : Hall F  
Stall No. : F1.6

### ACUTRONIC INDIA PRIVATE LIMITED

Name : Solasa Harish  
Phone : 9553682851  
Email : asingh@acutronic.ch  
Website : www.acutronic.com  
Contact Person Name : Abhijeet Singh

#### Profile

Acutronic is the global leader in the development, design, and manufacture of Inertial Guidance Test Systems (IGTS), Vibration Test Systems (VTS), and Hardware-In-The-Loop (HIL) motion simulators. These high-precision motion simulators are used in the aerospace, defense, automotive, and consumer electronics industries to test and calibrate inertial sensors (e.g., gyroscopes and accelerometers that measure movement); Inertial Navigation Systems; stabilized electro-optics; Electronic Stability Control Systems; and the in-flight engagement scenarios of missiles. Systems include single- and multi-axis rate tables, flight motion simulators and target motion simulators. Acutronic India Pvt. Ltd, based in Hyderabad, India was incorporated to deliver the best quality products, the best service, and the best customer experience for all the existing and upcoming systems in India. Furthermore, Acutronic is pleased to support the Government of India's "Make in India" policy and will be looking at ways to add value domestically in India.



Hall No. : Hall C  
Stall No. : C7.2,C7.3,C7.4,C7.5

### ADANI DEFENCE SYSTEMS AND TECHNOLOGIES LIMITED

Name : Sarvam Desai  
Phone : 90999 00956  
Email : sarvam.desai@adani.com  
Website : www.adanidefence.com  
Contact Person Name : Sarvam Desai

#### Profile

We at Adani Defence & Aerospace are committed to help India achieve self-reliance in defence & security. In a short span, we have established capabilities in India across a wide domain such as small arms, unmanned aerial systems, radars, defence electronics & avionics, tactical communication systems, and electro-optical systems with a proven record to support the Indian Armed Forces and other para-military forces in India. Adani Defence has established India's first unmanned aerial vehicles manufacturing facility, India's first private sector small arms manufacturing facility and is currently in process of setting up India's first comprehensive aircraft MRO facility in Nagpur. With the emerging threat of rogue drones, we have taken an initiative of implementing counter drone systems for both defence & civil applications. Through its comprehensive ecosystem of Tier I & Tier II capabilities across the defence supply chain, Adani is well-positioned to facilitate integration of larger platforms.

Hall No. : Hall C  
Stall No. : C1.12

### ADDEV MATERIALS PRIVATE LIMITED

Name : Jaganathan PK  
Phone : 9738401941  
Email : ragav@addevmaterials.com  
Website : www.addevmaterials.in  
Contact Person Name : Jaganathan PK

#### Profile

ADDEV Materials Private Limited, Bengaluru is a focussed supplier of Coatings, Chemicals & Consumables for Aerospace and Defence Industries in India. Addev Materials has range of Business activities involving Manufacturing, Custom Packaging, Material Conversion (Films & Tapes) and Distribution. Key Product ranges of ADDEV Materials Private Ltd in India are • P a i n t s & Coatings • Surface Treatment Chemicals • Adhesives & Sealants • Tools, consumables and Paint Shop Accessories. The unit is Certified to AS 9120 and ISO 9001 Quality Management Standard. ADDEV Materials is actively exploring opportunities to Make in India the Current generation of products to support Indian Aerospace and Defence industries

Hall No. : Hall A  
Stall No. : A3.2,A3.1

### ADRY'S TECHNOLOGIES

Name : Channamallaiah Gurusiddaiah Muchandimath  
Phone : 9448080673  
Email : ullas@adrystech.com  
Website : www.adrystech.com  
Contact Person Name : Shyamal Mahajan

#### Profile

Data Device Corporation (DDC) is dedicated to supplying quality products, on-time delivery, and superior support, all of which contribute to the success of our customers and the critical missions they serve. The following values are at the core of DDC's commitment to superior service and total customer satisfaction, and enable us to deliver greater value and support.

Hall No. : Hall F  
Stall No. : F2.2

### AERO REL SYSTEMS PRIVATE LIMITED

Name : SUBRAMANYA SRIDHAR MEKA  
Phone : 09492961818  
Email : aereorelsys@aereorelsys.com  
Website : Aero Rel Systems Private Limited  
Contact Person Name : RAMESH LAKAVATH

#### Profile

Aero Rel Systems Private Limited, would like to introduce ourselves as an organization comprising of highly motivated team of qualified and experienced engineers and professional experts of various disciplines specializing in Design & Development of sophisticated subsystems for Aerospace, Defence & Space Industries.

Hall No. : Hall C  
Stall No. : C3.3

### AEROSUN MEDIA PRIVATE LIMITED

Name : AEROSUN MEDIA PVT LTD  
Phone : 9449061925  
Email : info@aeromag.in  
Website : www.aeromagonline.com  
Contact Person Name : SUNNY JEROME

### Profile

AEROMAG ASIA is a prominent Aerospace and Defence Magazine published from the Aerospace Capital of India - Bangalore. As a Premier Aerospace & Defence Publication, it is official Media Partner for Aero India & Def Expo in India and publish official Show Dailies. Aeromag is also official Media Partner for most of the Global Aerospace and Defence events and publishing Special issues. Supported by the Indian Aerospace Industry, Aeromag, both print and online editions are reaching the decision makers of the Indian Defence sector.

Hall No. : Hall  
Stall No. : C3.6

### AGNI CONTROLS

Name : Mr. Arunkumar Balachandran  
Phone : 7448914999  
Email : marketing@agnicontrols.com  
Website : www.balafire.com  
Contact Person Name : ARUNKUMAR BALACHANDRAN

### Profile

Agni Controls, Chennai is Industrial Fire Protection Company. We are OEM Manufacturer, Exporter and system provider of Special Application fire detection and fire suppression products & Systems. Agni Controls has 37 years of experience in Fire Protection. In-house facility includes R&D, Design, Manufacturing, Assembling & Testing facilities. Uncompromised Quality Control policy is our strength. Agni Controls under brand name fladet series.. Manufactures various types of special application detectors like Flame, Ember, Spark & Probe type heat detectors, all Indigenously Designed, Manufactured, Assembled & Tested by Agni Controls in Chennai, India meeting National and International Standards. All the extinguishing system & their components are Designed, Manufactured and Assembled & Tested under brand name balawa series. Being a manufacturer of core products in Extinguishing & Detection System enables Agni Controls to be a strong OEM supplier to many machinery manufacturer, EPC, other fire protection System Integrators in India

Hall No. : Hall G  
Stall No. : G4.7

### AIRBORN INTERNATIONAL

Name : Vipin Kumar William  
Phone : +44 1732864930  
Email : williamv@airbornint.com  
Website : www.airborn.com  
Contact Person Name : Vipin Kumar William

### Profile

AirBorn is a 100% employee-owned company headquartered in Georgetown Texas, whose core business is engineering & manufacturing specialized connectors & electronic components for Original Equipment Manufacturers (OEMs) worldwide. AirBorn's solutions are relied upon by defence, aerospace, medical, & industrial leaders, to operate their most critical systems, in the most demanding environments. Our core products are connectors, flexible circuits, Custom design power supply, cable harness and Box build

Hall No. : Hall C  
Stall No. : C7.1

### AIRBUS SAS

Name : Serena Di Martino  
Phone : +33 673821168  
Email : serena.dimartino@airbus.com  
Website : www.airbus.com  
Contact Person Name : Serena Di Martino

### Profile

Airbus is a global pioneer in the aerospace industry, operating in the commercial aircraft, helicopters, defence and space sectors. Airbus is a leader in designing, manufacturing and delivering aerospace products, services and solutions to customers on a worldwide scale. With around 130,000 employees and as the largest aeronautics and space company in Europe and a worldwide leader, Airbus is at the forefront of the aviation industry. We build the most innovative commercial aircraft and consistently capture about half of all commercial airliner orders. Thanks to our deep understanding of changing market needs, customer focus and technological innovation, we offer products that connect people and places via air and space.

Hall No. : Hall F  
Stall No. : F3.14

### AMADO TOOLS

Name : Deepak Sebastian  
Phone : 9845027726  
Email : amado@amadotools.com  
Website : www.amadotools.com  
Contact Person Name : MR. DEEPAK SEBASTIAN

### Profile

We are an AS9100 Certified Co. and are manufacturers of Hi-Precision CNC Machined Components and Assemblies for Aerospace application, WE MANUFACTURE AEROSPACE GRADE : ACTUATORS, SERVO VALVES, SOLENOID VALVES, PYRO-SYSTEMS, FASTENERS, HOSE END FITTINGS, TITANIUM BOLTS & NUTS

Hall No. : Hall H  
Stall No. : H4.3

### AMETEK INDIA

Name : Varun Kumar  
Phone : 9380535478  
Email : varunkumar.vasanth@ametek.com  
Website : www.ametek.in

#### Profile

AMETEK is a global manufacturer of electronic instruments and electromechanical devices serving aerospace and military markets. We are an industry innovator developing a comprehensive line of sophisticated products that caters to every aspect of military and defense applications including but not limited to Manufacturing, R&D, Production, Quality control & Special requirements.

Hall No. : Hall F  
Stall No. : F4.6,F4.7

### AMI METALS UK LIMITED

Name : Andrew Cooke  
Phone : 16153770400  
Email : acooke@amimetals.com  
Website : www.amimetals.com

#### Profile

AMI Metals is a industry leading provider of Aerospace aluminium product. Our vast inventory of sheet, plate, rod, bar, and extruded products enables us to support all of your raw material needs, delivery the highest quality at the best value.

Hall No. : Hall A  
Stall No. : A8.4

### AMPHENOL INTERCONNECT INDIA PVT. LTD.

Name : ASHISH MATHUR  
Phone : 7709003153  
Email : ashishm@amphenol-in.com  
Website : www.amphenol-in.com  
Contact Person Name : Ashish Mathur

#### Profile

Amphenol is one of the largest manufacturers of interconnect products in the world. The Company designs, manufactures and markets electrical, electronic and fiber optic connectors, coaxial and flat-ribbon cable, and interconnect systems.

Hall No. : Hall A  
Stall No. : A1.3

### ANANYA TECHNOLOGIES PRIVATE LIMITED

Name : NARESH RAIKAR  
Phone : 9986929182  
Email : naresh@ananyatech.in  
Website : www.ananyatech.in

#### Profile

Ananya Technologies Pvt. Ltd caters to Ground Based, Airborne requirements in Aerospace and Defence verticals in the field of pressure sensing, vacuum generation, accurate pressure measurement, calibration and Micro controller based electronic control. Ananya has implemented Quality management system as per EN 9100:2018 standards. At Ananya, the customer is at the center of everything we do and we strive to develop products that are in line with our customers' expectations in product quality, performance and on time delivery by creating quality consciousness among the employees & continually improving the effectiveness of Quality Management System. We have hitherto developed and supplied a sizable number of flight critical assemblies for our current major customer Hindustan Aeronautics Limited Bangalore with an impeccable service record. We have indigenized the MIL 1553 data bus coupler for the fixed wing fighter aircraft. Ananya also has expertise in Built-to-Print, System Integration and Inter-connect harnesses.

Hall No. : Hall C  
Stall No. : C3.8,3.9

### ANIL METALS & ALLOYS PRIVATE LIMITED

Name : Kashish Jain  
Phone : 9884291019  
Email : anilmetals1997@yahoo.com  
Website : www.anilmetals.net  
Contact Person Name : Kashish Jain

#### Profile

Anil Metals Private Limited is an AS 9120B Certified Distributor of Aerospace Grade Metals.

Hall No. : Hall G  
Stall No. : G2.2

### ANJANA ENGINEERING WORKS

Name : Naveen Pusala  
Phone : 9110709315  
Email : naveen@anjanaengg.in  
Website : www.anjanaengg.co.in  
Contact Person Name : Managing Director

#### Profile

Anjana Engineering Works (aerospace and defense)

Hall No. : Hall B  
Stall No. : B1.2

### ANKIT AEROSPACE PRIVATE LIMITED

Name : ANKIT PATEL  
Phone : 9945085453  
Email : yamuna.at@ankitgroup.com  
Website : https://www.ankitaerospace.com  
Contact Person Name : ANKIT PATEL



### Profile

Headquartered in Bangalore, Ankit Aerospace is one of India's leading aerospace component manufacturers specializing in the production of complex machine parts, fluid fittings and small assemblies. We meet the aerospace industry's demand for specialized products with our engineering expertise. Operational excellence, quality output, and on-time delivery are a few tenets that make us one of India's leading aerospace component manufacturers. Our core strength lies in manufacturing high-precision, high-performance components using next-gen technology. Backed by four decades of expertise, we follow lean engineering practices to minimize waste and maximize output.

Hall No. : Hall F  
Stall No. : F1.7

### APEXPLUS TECHNOLOGIES

Name : Shashank Mutha  
Phone : 8099337510  
Email : shashank@apexplustech.com  
Website : www.apexplustech.com  
Contact Person Name : Sagar Deshpande

### Profile

ApexPlus Technologies is involved in the indigenous design and manufacturing of wireless solutions for industrial sensor monitoring, data logging. We also develop microwave, RF+FPGA based signal processing systems for defence labs and DPSUs and a part of many prestigious radar projects.

Hall No. : Hall F  
Stall No. : F2.7

### APOLLO AEROSPACE COMPONENTS INDIA PRIVATE LIMITED

Name : Suman K K  
Phone : 9844060249  
Email : suman.kumar@apollo-aerospace.com  
Website : https://www.apollo-aerospace.com/  
Contact Person Name : Gopu Sundararajan

### Profile

For 50 years, one of Apollo's core businesses has been supplying fasteners and hardware for aerospace and defence applications.

Hall No. : Hall F  
Stall No. : F5.8, F5.7

### APOLLO MICRO SYSTEMS LIMITED

Name : BADDAM KARUNAKAR REDDY  
Phone : 040-27167000  
Email : info@apollo-micro.com  
Website : apollo-micro.com  
Contact Person Name : P RAGHAVENDER RAJ

### Profile

Design Development and production of Rugged Custom Built Hardware and Software Solutions for Mission Critical Application

Hall No. : Hall A  
Stall No. : A3.4

### AQUASCAPE ENGINEERS PRIVATE LIMITED

Name : DHARMENDRA MEHTA  
Phone : 7383669869  
Email : aquascape.operations@gmail.com  
Website : www.aerospaceengineering.in  
Contact Person Name : DHARMENDRA MEHTA

### Profile

Aquascape Engineers Pvt Ltd is one of an Indian AS9100D & ISO 9001:2015 Certified Company & specialized in Aerospace CNC machining, particularly in high precision components with complex geometries, ensures that your product specifications are met on time and within budget. We have invested in world class 2 Axis to 5 Axis machineries from Mazak, DMG Mori & CMM from Zeiss. NX CAD/CAM software for Design & Manufacturing & Full ERP system to ensure proper traceability. We are also in the field of Fountains and Fountains components Manufacturing Industry since 1969. Aquascape Engineers has spread his market worldwide by exporting its products in more than 60 Countries. We have the expertise and resources to deliver any type of CNC machining parts to any location in the world on a very short lead-time. We welcome the opportunity to become your manufacturing partner.

Hall No. : Hall H & CHALET  
Stall No. : H4.1, H4.2, CHALET.19, 20

### ARMY AVIATION

Phone : 080 25231538  
Email : testcrewaatt@gmail.com  
Website : www.indianarmyaviation.in

### Profile

Army Aviation Equipment

Hall No. : Hall F  
Stall No. : F6.1,F6.2

### ASTRA MICROWAVE PRODUCTS LIMITED

Name : Vaibhav Agarwal  
Phone : 9810445229  
Email : vaibhav.a@astramp.com  
Website : www.astramp.com  
Contact Person Name : Vaibhav Agarwal

#### Profile

M/s. Astra Microwave Products Limited (AMPL) was incorporated as a private limited Company in 1991 and was subsequently converted to a public limited company in 1995. Today the company has grown to about 1200 employees with an average annual turnover > Rs. 400 Cr. / 65 Million USD in the last 4 years. AMPL is ISO 9001:2015 and AS 9100:Revision D certified.

Hall No. : Hall C  
Stall No. : C4.3

### ASTRA RAFAEL COMSYS PRIVATE LIMITED

Name : Rohit Rathod  
Phone : 8860625530  
Email : arcmarketing@astrafaelcomsys.com  
Website : www.astrafaelcomsys.com  
Contact Person Name : Rohit Rathod

#### Profile

Astra Rafael Comsys Pvt Ltd (ARC) is a company registered under the Indian Companies Act, 2013. It is a Joint Venture (JV) company formed between Astra Microwave Products Ltd ("AMPL"), India, and Rafael Advanced Defence Systems ("Rafael"), Israel, engaged in specific System areas of Defence Electronics viz, Tactical Communication Systems, Electronic Warfare and Signal Intelligence (SIGINT). Setting high standards, this registered Start-up & AS 9100 D, ISO 14001 & EMS 27001 certified company is working towards carving a niche for itself in the Defence & Aerospace segment.

Hall No. : Hall A  
Stall No. : A3.13

### ATEQ SYSTEMS ANALYTIC INDIA PRIVATE LIMITED

Name : PRAMOD GEORGE  
Phone : 9445563686  
Email : ateqchennai@ateqindia.com  
Website : www.ateqindia.com  
Contact Person Name : SURESH A G

#### Profile

ATEQ Systems Analytic India Pvt Ltd is a manufacturer of automated testers for all types of aircraft. In order to assist aviation manufacturing and maintenance, ATEQ has developed a complete range of products and customized hardware and software solutions, adapted to all industry requirements: pneumatic, electric and electronic safety system tests. We are also manufacturing Pitot-Static adapters, and covers.

Hall No. : Hall  
Stall No. : F1.10,F1.9

### AVDEL (INDIA) PRIVATE LIMITED

Name : AMIT MENDON  
Phone : 9717494986  
Email : amit\_mendon@yahoo.com  
Website : www.avdel.com  
Contact Person Name : AMIT MENDON

#### Profile

Avdel (India) Pvt. Ltd was established in 1961 and is a part of a well-established group of companies with interests in various business sectors including Aerospace, Aviation, Automotive, and Rail amongst others. Avdel India is an AS 9120 B & ISO 9001:2015 Certified company. With headquarters in Mumbai (India), Avdel India has regional offices in Bengaluru (the aerospace hub of the country) and sales office in Hyderabad, and Trivandrum.

Hall No. : Hall B  
Stall No. : B5.3

### AVIAHELP

Phone : +7-4952217822  
Email : reception2@aviahelp.ru/info@beta-air.com  
Website : www.aviahelp.com/www.beta-air.com

#### Profile

Aviahelp is a large Russian supplier of aviation spares for Russian Helicopters and aircrafts delivers spares from own warehouse: Moscow (RF), Cincinnati (USA), Sharjah (UAE), to more than 40 countries.

Hall No. : Hall C  
Stall No. : C4.1

### AVIAZAPCHAST PLC

Name : Valeriy Michurin  
Phone : +7 495 7370526  
Email : michurin@aviazapchast.ru  
Website : http://aviazapchast.com/  
Contact Person Name : Dzheruk Viktor

### Profile

Aviazapchast PLC is one of the leading Russian private companies specializing in technical support of aircrafts of civil and dual application of Russian and foreign origin. The Company's core business consists in carrying out integrated MRO programs for airplanes and helicopters, supplying spare parts, components and major assemblies, navigation systems, test equipment and high-tech alloys for aerospace companies, implementing aircraft upgrading programs, as well as providing various logistics and warehousing services. Aviazapchast PLC has been actively supporting its presence in the global aviation market. Permanent representative offices of Aviazapchast PLC are operating in Algeria and India.

Hall No. : Hall G  
Stall No. : G1.6

### AVI-OIL INDIA PRIVATE LIMITED

Name : Chandra Joshi  
Phone : 9810633329  
Email : chandra@avi-oil.com  
Website : www.avi-oil.com  
Contact Person Name : Chandra Joshi

### Profile

AVI-OIL India [P] Ltd., is a joint venture of Indian Oil Corporation, Balmer Lawrie & Co Ltd. & Nyco, France established for the indigenous production / supply of aviation and allied lubricants to the Defence Services, Civil Aviation and the industrial sector. A wide range of products for aircraft, military and industrial equipment are being produced at the manufacturing facility located at village Piyala, in District Faridabad, Haryana, 45 km from New Delhi.

Hall No. : Hall H  
Stall No. : H2.3

### AXIOMATIC ITECH PRIVATE LIMITED

Name : Surinder Singh Narula  
Phone : 8826555884  
Email : surinder@axiomatic.in  
Website : www.axiomatic.in  
Contact Person Name : Surinder Singh Narula

### Profile

Axiomatic is the Indian Distributor of the CFD++ Suite of Software from Metacomp Technologies, Inc. USA. CFD++ is established as the Market Leader in the Indian Defence & Aerospace Industries as it is Robust, Accurate, Fast & Trusted to Consistently deliver Reliable Solutions. CFD++ is the Best-in-class CFD Solver used to solve the most difficult class of problems, accurately, and is

backed by Unmatched support. Axiomatic is also the Indian distributor of the ModeFRONTIER Suite of Software from ESTECO, Italy. ESTECO is an independent software provider, highly specialized in numerical optimization and simulation data management with a sound scientific foundation and a flexible approach to customer needs. ESTECO helps companies excel throughout their innovation journey, by providing them with leading-edge technology to master engineering complexity and accomplish the shift to agile product development. Over 300 leading international organizations have chosen ESTECO to consolidate specialized expertise, streamline teamwork, and boost product development.

Hall No. : Hall B  
Stall No. : B1.1

### AXISCADES TECHNOLOGIES LIMITED

Name : VIJAY KUMAR B  
Phone : 97419088800  
Email : b.vijay@axiscades.in  
Website : https://www.axiscades.com/  
Contact Person Name : Vijay Kumar B

### Profile

AXISCADES is a leading technology & engineering solutions company of 3+ decades, catering to the futuristic needs of various industries such as Aerospace, Defence, Automotive, Off-highway, Energy and others. Our deep domain expertise across commercial, business and military aircraft both in fixed wing and rotary aircraft segments has enabled us to co-create innovative solutions across the lifecycle. Headquartered in Bengaluru (India) with our office's and GEC's (16) spread across 8 countries, AXISCADES is a step closer to our clients. Owing to a long Defence pedigree, we excel in designing and developing advanced, compute-intensive, MIL Certifiable Aerospace and Defense solutions for a wide range of Ground, Air and Naval applications. We are a recognized Indian Offset Partner with Defence manufacturing license in India. Fuelled by our passion for driving innovation and business transformation across domains, we address the needs of Global OEM's and Government entities by providing latest cutting edge innovative products & services.

Hall No. : Hall A  
Stall No. : A1.6,A1.7

### AXON INTERCONNECTORS AND WIRES PRIVATE LIMITED

Name : Stephane Watier  
Phone : 9606082318  
Email : s.watier@axon-cable.com  
Website : www.axon-cable.com  
Contact Person Name : Stephane Watier

### Profile

Headquartered in the beautiful Champagne region of France, Axon Cable is a worldwide leader in specialist interconnect. The group designs and manufactures custom design wires, composite cables, flat flex cables, cable assemblies, connectors and mini-systems for high tech applications. Axon has state of the art facility in Bangalore in KIADB Aerospace Park dedicated for Manufacturing Harness and Interconnect components

Hall No. : Hall A  
Stall No. : A7.4b

### AZAD ENGINEERING PRIVATE LIMITED

Name : BALAJI P R  
Phone : 9930679740  
Email : balaji@azad.in  
Website : <https://www.azad.in/>  
Contact Person Name : Balaji P R

### Profile

Azad Engineering, is a manufacturer of highly engineered complex precision parts required for aerospace, power generation and oil & gas OEMs. Azad has positioned itself as a technology-driven and innovative company with manufacturing facilities meeting global standards.

Hall No. : Hall F  
Stall No. : F6.5

### AZISTA INDUSTRIES PRIVATE LIMITED

Name : AJAY ACHARYA K V  
Phone : 9945539088  
Email : ajayacharya.kv@azistaindustries.com  
Website : [www.azistaerospace.com](http://www.azistaerospace.com)  
Contact Person Name : Ajay Acharya K V

### Profile

Azista Industries is an Indian organization with vastly diverse business interests ranging from manufacturing of Satellites, Composite Materials for stringent application in Aerospace and Defence, Counter Drone Systems, UAVs, Satellite Communication, Automated Weather Monitoring systems. The company has made large investments in building competency to be market leaders in the respective businesses.

Hall No. : Hall A  
Stall No. : A1.2

### BASHI AEROSPACE PRIVATE LIMITED

Name : Akhil Khanna  
Phone : 9845024666  
Email : bashi\_aerospace@yahoo.com  
Website : [www.blissaerospace.com](http://www.blissaerospace.com)  
Contact Person Name : Mr. Arun Kumar

### Profile

BASHI AEROSPACE PRIVATE LIMITED, a company in the Aerospace Sector for the past 31 years working with Indian DPSU's for manufacturing of the following items, •1. Bolts & Screws (Hexagonal Head bolts, Pan Head Screws, CSK head screws) •2. Nuts (Plain Hexagon Nuts, Anchor Nuts) •3. Quick Release Pins •4. Quarter Turn fasteners •5. Clamps •6. Studs •7. Electrical Braids •8. Gas charging Valves and non return valves •9. Rivets

Hall No. : Hall E  
Stall No. : E3.2,E3.3

### BEML LIMITED

Name : HIMANSHU PRASAD  
Phone : 9739658241  
Email : himanshuprasad07@gmail.com  
Website : [www.bemlindia.in](http://www.bemlindia.in)  
Contact Person Name : HIMANSHU PRASAD

### Profile

BEML Limited is a Schedule-A company under Ministry of Defence, Government of India. The Company, plays a pivotal role and serves India's core sectors like Defence, Rail, Power, Mining and Infrastructure. The Company has been able to achieve a turnover of more than INR.3,500 Cr. The Company operates under three Business verticals viz., Mining & Construction, Defence & Aerospace and Rail & Metro. BEML's products are sold and serviced through its Marketing Network spread all over the Country and are exported to more than 68 countries. The full-fledged service centres offer total equipment care, maintenance contracts and rehabilitation services. The company has a dedicated R&D infrastructure and team to meet the technological demands through in-house and tie-ups with global players.



Hall No. : Hall B  
Stall No. : B5.33

### BEVEL GEARS (INDIA) PRIVATE LIMITED

Name : Abdulla Jamal  
Phone : 9901510000  
Email : akthar.s@bevelgearsindia.com  
Website : www.bevelgearsindia.com  
Contact Person Name : Abdulla Jamal

#### Profile

Bevel Gear (India) Pvt. Ltd. are pioneers in bevel gears and custom gearboxes for the Indian aerospace and defence industry with over 4 decades of experience. The unique capabilities include both Gleason and Klingelnberg systems across an extremely broad size range by global standards: - Straight bevels : 0.3 – 30 Module - Spiral bevels : 0.3 – 40 Module Facilities include: - CNC spiral bevel gear grinding - CNC GMS gear analyzing - STRAIGHT bevel gear grinding - Prototype gearing and small batches - Reverse Engineering capabilities for discontinued legacy parts - Fine pitch spur and helical gears - Cube bevel and custom gearboxes - Gear measuring services BGI is ready to assist you with your defence gearing requirements.

Hall No. : Hall E  
Stall No. : E.4.2,E.4.3,E.4.5,E.4.6

### BHARAT DYNAMICS LIMITED

Name : M RAVI  
Phone : +91 8985734304  
Email : bdbdl@bdl-india.in  
Website : https://bdl-india.in  
Contact Person Name : M RAVI

#### Profile

Headquartered in Hyderabad, Bharat Dynamics Limited (BDL), was incorporated on 16 July, 1970 as Public Sector Undertaking under Ministry of Defence, Government of India. Over the years, BDL has evolved as one among few industries in world having state-of-the-art facilities for manufacture and supply of Guided Missiles, Underwater Weapons, Air-borne products and allied defence equipment for Indian Armed Forces. BDL also offers Product Life Cycle Support and Refurbishment / Life Extension of vintage Missiles. While fulfilling its basic role as guided weapon system manufacturer, BDL has built-up in-house R&D capabilities primarily focused on Design & Engineering activities. BDL has forayed into international market by offering its products to foreign countries. BDL is currently executing export order of Torpedoes and is geared up to take up export orders of Akash Weapon System. Thrust is being given to explore tie-ups with OEMs for new missiles and underwater weapons for potential Transfer of T

Hall No. : Hall E & CHALET  
Stall No. : E.4.1, CHALET.39, CHALET.40, OD.03

### BHARAT ELECTRONICS LIMITED

Name : Hariharan E A  
Phone : 9845687006  
Email : hari@bel.co.in  
Website : https://bel-india.in  
Contact Person Name : Hariharan E A

#### Profile

Bharat Electronics Limited (BEL) is a Navratna PSU under the Ministry of Defence, GoI. BEL is a multi-technology, multi-Unit conglomerate having products in the areas of Radars, Missile Systems, Military Communications, Naval Systems, Electronic Warfare & Avionics, C4I Systems, Electro Optics, Tank Electronics & Gun/Weapon System Upgrades and Electronic Fuzes in the Defence segment. BEL's non-Defence business segment includes areas such as EVM, Homeland Security & Smart Cities, Satellite Integration & Space Electronics, Railways, AI, Cyber Security, Energy Storage Products, besides Composite Shelters & Masts. BEL's customers include the Army, Navy, Air Force, Coast Guard, Paramilitary Force, Police, state government departments and consumers of professional electronic components. BEL recorded a turnover of Rs. 15,044 Cr in FY 2021-22, a growth of 9% over the previous year, despite challenges posed by pandemic. The Company recorded an Export turnover of 33.30 Million USD and achieved Market Capitalisation of Rs. 80,000 Cr.

Hall No. : CHALET  
Stall No. : CHALET.35

### BHARAT FORGE LIMITED

Name : Dipak Shinde  
Phone : 7743857912  
Email : dipak.shinde@bharatforge.com  
Website : www.bharatforge.com  
Contact Person Name : Dipak

#### Profile

Kalyani Group is an Indian multi-national with high technology, engineering & manufacturing capability across critical sectors such as Engineering Steel, Automotive, Industrial, Renewable Energy, Urban Infrastructure & Specialty Chemicals. With global manufacturing footprints - 3 in Germany, and one each in Sweden, France and USA, and end-to-end capability, it has an annual turnover of over 12,000 Crores. In its Defence profile, it has realised major breakthroughs in Artillery Systems with indigenously developed series of 155/52/45/39 cal guns, ULHs and Mounted systems. It continues to break new barriers in segments like Protected Vehicles, Ammunition, Missiles and Air Defence, Small Arms and Defence Electronics. In its Aerospace vertical, it is a leading supplier of various components - airframe, structural and engine parts for the aviation sector. Over the years, the group continues to invest in state-of-the-art facilities harbouring world-class products, facilities and capabilities to achieve flawless excellence in these sectors.

Hall No. : Hall B  
Stall No. : B5.30,B5.29

### BIKAR AEROSPACE

Name : Prasad RS  
Phone : 02751 9551 110  
Email : prasad.rs@bikar.com  
Website : www.aerospace.bikar.com  
Contact Person Name : Prasad RS

#### Profile

Aerospace Raw Material Distributor

Hall No. : Hall C  
Stall No. : C3.11

### BISEN AEROSPACE PRIVATE LIMITED

Name : Ranjeet Singh Bisen  
Phone : 9901522733  
Email : ranjeet@bisen aerospace.com  
Website : www.bisen aerospace.com  
Contact Person Name : Ranjeet Singh Bisen

#### Profile

Bisen Aerospace Private Limited (BAPL) is AS9100D Certified high precision parts manufacturing company that offers end to end services for complex, high precision mechanical requirements. We supply fully finished precision parts or mechanical sub assemblies ready for further integration. BISEN Aerospace Facilities are equipped with state-of-the-art VMC and Turn Mills machining capabilities that follow robust systems and processes approved by major OEMs and global aerospace companies. BISEN Aerospace specializes in delivering solutions for the aerospace, high-frequency and microwave electronics, medical & telecommunication industries. we have significant experience in working with global OEMS and their supply chains, meeting their stringent requirements.

Hall No. : Hall A  
Stall No. : A1.1

### BLISS AEROSPACE COMPONENTS PRIVATE LIMITED

Name : Akhil Khanna  
Phone : 9845024666  
Email : bliss.aerospace@yahoo.in  
Website : www.blissaerospace.com  
Contact Person Name : Akhil Khanna

#### Profile

Bliss Aerospace Components Private Limited., a company in the Aerospace Sector for the past 10 years with AS 9100 Rev D Certification for manufacturing and NADCAP Certified for Chemical Processing. BLISS AEROSPACE IS CURRENTLY WORKING IN THESE VERTICALS, 1.Manufacturing of Aerospace Grade Fasteners and other smaller assemblies. •1. Bolts & Screws (Hexagonal Head bolts, Pan Head Screws, CSK head screws) •2. Nuts (Plain Hexagon Nuts, Anchor Nuts) •3. Quick Release Pins •4. Quarter Turn fasteners •5. Clamps •6. Studs •7. Electrical Braids •8. Gas charging Valves and non return valves •9. Rivets 2. Bliss Aerospace can source Aerospace parts. 3. Bliss Aerospace is NADCAP certified for Chemical Processing •a. CADMIUM PLATING •b. STAINLESS STEEL PASSIVATION •c. ANODIZING (Chromic Acid, Sulfuric Acid, Hard Anodize) •d. ELECTROLESS PLATING •e. ZINC PLATING 4. Bliss Aerospace provides Engineering Services.

Hall No. : Hall A  
Stall No. : A1.8

### BLUEKEI SOLUTIONS PRIVATE LIMITED

Name : Ajit Mutalik  
Phone : 8007588200  
Email : ajit@blue-kei.com  
Website : www.blue-kei.com  
Contact Person Name : Ajit Mutalik

#### Profile

BlueKei Solutions specialises in establishing integrated Digital Engineering practices in organisations through Systems Engineering methodologies and processes. BlueKei solves specific operational / engineering problems, integrate emerging technologies and achieve innovation and operational excellence through adoption of digital engineering techniques.

Hall No. : Hall A  
Stall No. : A7.2

### BOEING

Name : Thomas Herpel  
Email : thomas1.r.herpel@boeing.com  
Website : www.boeing.com  
Contact Person Name : Thomas Herpel

#### Profile

Boeing develops, manufactures and services commercial airplanes, defense products and space systems for customers in more than 150 countries.

Hall No. : Hall F  
Stall No. : F1.5

### **BOLLHOFF FASTENINGS PRIVATE LIMITED**

Name : Argha Karmakar  
Phone : 8826555884  
Email : akarmakar@boellhoff.com  
Website : www.boellhoff.in  
Contact Person Name : Argha Karmakar

#### **Profile**

Fastening solutions and assembly technology

Hall No. : Hall E  
Stall No. : E3.1A

### **BRAHMOS AEROSPACE**

Name : Praveen Pathak  
Phone : 9810644473  
Email : rahultripathi@brahmos.com  
Website : BrahMos Aerospace  
Contact Person Name : Praveen Pathak

#### **Profile**

BrahMos Aerospace is responsible for Design, Development, Production & Marketing of world's best universal supersonic cruise missile - "BRAHMOS". The missile has a long range of 290 km and can be launched from Sea, Sub-sea, Land & Air based platforms. BRAHMOS flies at supersonic speed all through the flight and is capable of engaging any kind of land and sea targets beyond the horizon in multi-threat environment. Missile is capable of defeating modern CIWS. The BRAHMOS weapon system is already in service with all three arms of the Indian Armed forces and would be exported to few friendly countries.

wide experience of system integration and after sales service support in climatically challenging areas as well as CIO areas. Brij Systems works closely with Armed forces in India and has a proven track record of after sales service and support in all field conditions.

Hall No. : Hall C  
Stall No. : C2.4

### **CADOPT TECHNOLOGIES PRIVATE LIMITED**

Name : Prabir Dhar  
Phone : 7625034896  
Email : prabir@cadopt.com  
Website : www.cadopt.com  
Contact Person Name : Prabir Dhar

#### **Profile**

CADOpt Technologies Private Limited, is a market leader for providing Engineering Services and Solutions, mainly in the areas of CAD (Computer Aided Design) / CAM (Computer Aided Manufacturing) / CAE (Computer Aided Engineering) / PDM (Product Data Management) / PLM (Product Lifecycle Management) / IoT (Internet of Things) to the various industry verticals.

Hall No. : Hall B  
Stall No. : B5.23

### **CAPTRONIC SYSTEMS PRIVATE LIMITED**

Name : Niranjana Malode  
Phone : 9028998632  
Email : niranja@captronicsystems.com  
Website : www.captronicsystems.com  
Contact Person Name : Niranjana Malode

#### **Profile**

Captronic Systems Private Limited, now a Safran group of Company is an ISO 9001:2015, AS 9100(D) and was founded in 1999. CSPL is a Department of Scientific & Industrial Research (DSIR), Govt. Of India recognized R&D Lab. CSPL is specialized design and development solutions company for automated test equipment, data acquisition and control systems, for R&D, design validation and production testing. CSPL Clients includes DRDO labs, HAL and other PSU's involved in prestigious projects like Light Combat Aircraft (LCA), RUSTOM-II UAV, Airborne Early Warning and Control System (AWACS), ISTAR, Man and Moon Mission of ISRO. CSPL is working with Aerospace Sector, Defence Sector, Space Sector, Automotive Sector and have accomplished projects with various Government Establishments across India. With a team of over 120 qualified engineers Captronics have executed over 2000 projects in last 23 years. Captronic Systems is now a 100% subsidiary of Safran Data Systems, France and a RF Specialty Partner of NI USA.

Hall No. : Hall A  
Stall No. : A2.4

### **BRIJ SYSTEMS LIMITED**

Name : Anjali Padte  
Phone : 9372501371  
Email : info@brijindia.com  
Website : www.brijindia.com  
Contact Person Name : Anjali Padte

#### **Profile**

Brij Systems Limited, a company founded in 1995 to provide data communication solution today offers products in areas of wireless communications, jamming systems, tactical communication, night vision, power backup and power generation, surge protection, towers and networking solutions. Brij Systems has

Hall No. : Hall B  
Stall No. : B5.25

### **CARRIS PIPES AND TUBES PRIVATE LIMITED**

Name : SANITH JACOB  
Phone : 9446562800  
Email : sales@carris.in  
Website : www.carriscases.in  
Contact Person Name : MANU G NAIR

#### **Profile**

CARRIS Extra Tough Cases, an aerospace and defence wing of Carris Group; involved in design and development, manufacture and supply of custom moulded, light weight, sturdy, rugged and most importantly eco-friendly products. Our boxes are manufactured through ROTO MOULDING technology as per MIL STD 810F, JSG 0102:1984 & JSS 0253 & 55555. Also our cases airworthiness has been certified by DGAQA, a defense wing of the Ministry of Defence. Rotational Moulding technology is contemporary and a step ahead of Fibre Reinforced Plastic (FRP), wooden & metal boxes. Our esteemed clients in India are HAL, BEL, Ordnance Factories and DRDO, and we export to various other countries as well. For more details about our products, please visit our website [www.carriscases.com](http://www.carriscases.com)

Hall No. : Hall B  
Stall No. : B5.4

### **CINGULARITY TOOLING AND ENGINEERING CONCEPTS INDIA PRIVATE LIMITED**

Name : Samuel Gerald  
Phone : 9886171088  
Email : sam@cingularity.in  
Website : www.cingularity.in  
Contact Person Name : Samuel Gerald

#### **Profile**

Cingularity TEC India Pvt Ltd Aerospace division, founded in 2014 is an industrial and military grade engineering and manufacturing company. A producer of small and large commercial drones, Cingularity provides revolutionary and effective aerial systems. Cingularity adapts its secure, proprietary aircraft structure components design and manufacturing including avionics for drone airborne mission, combining natural and accurate flight dynamics based on manned aviation flight paths and guidance systems. Cingularity offers new capabilities to the emerging drone industry with task-specific drones and systems enabling even the most challenging heavy lift, long endurance, and delivery missions, globally. We work for and partner with our clients HAL, DRDO Labs, IISc, NAL, L&T, 3M, Samsung India and many more prestigious organizations.

Hall No. : Hall G  
Stall No. : G2.5

### **COGNE ACCIAI SPECIALI SPA**

Name : Elisa Corrado  
Phone : +39 0165 3021  
Email : elisa.corrado@cogne.com  
Website : www.cogne.com/

#### **Profile**

Cogne Acciai Speciali is a leading Italian manufacturer of stainless steels and nickel alloys long products. The Company's activities cover the five main production cycles of the steel industry: steelmaking, casting, rolling, forging and machining. CAS' product range includes stainless steels (in form of wire rod, bars, semi-finished products and concrete reinforcing bars), valve steels and nickel alloys.

Hall No. : Hall A  
Stall No. : A7.4a

### **COLLINS AEROSPACE**

Name : Hardik Someshvar  
Phone : 9916117221  
Email : hardik.someshvar@collins.com  
Website : www.collinsaerospace.com  
Contact Person Name : Hardik Someshvar

#### **Profile**

At Collins Aerospace, we dream, design and build without limits – so our customers can do the same. By reaching across the markets we serve and drawing on our vast portfolio of expertise, we are making the most powerful concepts in aerospace a reality every day. Explore all the ways we're pushing the boundaries of what's possible with one of the deepest capability sets and broadest perspectives in the industry.

Hall No. : Hall C  
Stall No. : C1.9,C1.8

### **COMAVIA SYSTEMS TECHNOLOGIES PRIVATE LIMITED**

Name : Mayank Dalmia  
Phone : 9830815353  
Email : sales@cst.kahm.co  
Website : www.comavia.com  
Contact Person Name : Vinay Kumar

#### **Profile**

ComAvia, part of KAHM group's Aerospace vertical, is a CEMILAC certified systems & subsystems designer, assembler & integrator. Specializing in the Design and Development activity for the Indian Airforce, ComAvia has built deep domain expertise in the areas of Avionics, Test solutions and more generally, electronic hardware, software and embedded software. With 21 years of experience, ComAvia is proud of the numerous indigenous programs it has executed for the Indian armed forces and PSUs



Hall No. : Hall F  
Stall No. : F4.3

### COMPROTECH ENGINEERING PRIVATE LIMITED

Name : Murali V  
Phone : 9666634309  
Email : murali.v@comprotechengineering.in  
Website : <http://www.comprotechengineering.com/>  
Contact Person Name : MURALI .V

#### Profile

Fabrication and composite (compression moulding, epdm lining)

Hall No. : Hall B  
Stall No. : B5.20,B5.21

### COMPUPOWER PRIVATE LIMITED

Name : JAGADEESH P YERUBANDI  
Phone : 9849057441  
Email : info@compupowerindia.com  
Website : [www.compupowerindia.com](http://www.compupowerindia.com)  
Contact Person Name : JP YERUBANDI

#### Profile

Manufacturer of Data Bus Couplers, Data Bus Harnesses, Interface Transformers conforming to MIL-STD-1553B for Aerospace Applications

Hall No. : Hall F  
Stall No. : F2.3, 2.4

### CONNKT ELECTRONICS PRIVATE LIMITED

Name : Santhosh MB  
Phone : 9738144270  
Email : connekt@connekteletronics.in  
Website : [www.connekteletronics.com](http://www.connekteletronics.com)  
Contact Person Name : Finayan D'Silva

#### Profile

Connekt Electronics was established in April 1986 by founder and visionary Mr. K.G. Nair. For 35 years, Connekt has been a trusted consultant and authorized representative of Global OEMs of electronic and electromechanical components and devices, supplying to various Indian space, aerospace, defense, medical, railway and telecom customers.

Hall No. : Hall B  
Stall No. : B3.3

### CSIR NATIONAL AEROSPACE LABORATORIES

Name : SREEDHARA HARLANAYAKA  
Phone : 9739159633  
Email : hsreedhara@nal.res.in  
Website : <http://www.nal.res.in/>  
Contact Person Name : Sreedhara Harlanayaka

#### Profile

CSIR-National Aerospace Laboratories (NAL), is the only government aerospace R&D laboratory in the country's civilian sector. CSIR-NAL is a high-technology oriented institution focusing on advanced disciplines in aerospace. CSIR-NAL has several advanced test facilities, and many of them are recognized as National Facilities. These are not only the best in the country, but are also comparable to other similar facilities in the world. CSIR-NAL has provided significant value added inputs to all the Indian national aerospace programmes. CSIR-NAL has also developed many critical technologies for the strategic sector and continues to support the mission-mode programmes of the country. The CSIR-NAL's mandate is to develop aerospace technologies with strong science content, design and build small, medium sized civil aircraft, and support all national aerospace programmes.

Hall No. : Hall B  
Stall No. : B2.1

### DASSAULT AIRCRAFT SERVICES INDIA PRIVATE LIMITED

Name : Frédéric WALLOIS  
Phone : 33675841050  
Email : matthias.guillemin@gmail.com  
Website : [www.rafale.co.in](http://www.rafale.co.in)  
Contact Person Name : Frédéric WALLOIS

Hall No. : Hall A  
Stall No. : A5.4

### DASSAULT SYSTEMES INDIA PRIVATE LIMITED

Name : Renin Raj  
Phone : 8310124025  
Email : Renin.RAJ@3ds.com  
Website : [www.3ds.com](http://www.3ds.com)  
Contact Person Name : Renin Raj

#### Profile

A sustainable innovation leader. We provide virtual worlds that allow our clients to create innovative experiences for their own customers. Our aim is to achieve a new development model to address the major challenges facing the world today. We offer a

new approach to innovation and doing business in the experience economy. Our business is innovation. Thanks to the 3DEXPERIENCE platform, we provide software solutions that allow customers to create innovative new products and services using virtual experiences. Our aim is to build a new development model to address the major challenges facing the world today.

Hall No. : Hall C  
Stall No. : A6.1

### DATA PATTERNS (INDIA) LIMITED

Name : Thomas Mathuram Susikaran  
Phone : +91-7708024433  
Email : thomas@datapatterns.co.in  
Website : www.datapatternsindia.com  
Contact Person Name : S. Thomas Mathuram

#### Profile

Data Patterns is a Defence and Aerospace Electronics Systems Company. It develops products for Air, Land and Sea Platforms. Having worked with the Defence Research Development Organization (DRDO) and the Department of Space (ISRO), Data Patterns develops electronics systems covering the complete area of electronics from Microvolt to RF & Microwave, Processors, Digital, Analog, High Voltage, Power, FPGA, Automated Test Systems, Software, etc. Data Patterns today builds complete solutions in Radar, Electronic Warfare, Fire Control Systems, Avionics, Glass Cockpit, Sonar Systems, Data Link, Identify Friend or Foe (IFF) Systems, RF Seekers, etc. Data Patterns has about 450 Engineers in development and a staff strength of over 900 professionals. Data Patterns' production infrastructure is certified for Military Aircraft, Defence Systems, Launch Vehicles and Satellite products. The infrastructure includes 200,000 sq.ft Design and Production facility with certified Electronics Assembly Line (Automated Pick and Place, Underscope Inspection, X-ray Inspection, etc), certified Manual Soldering and Harness Preparation, Thermal Cycling Chambers, EMI/EMC and antenna test anechoic chambers, Vibration Table and required Assembly Test and Test and Measuring Instruments required for Defence production. Large systems and vehicle integration, satellite integration production facilities are available.

Hall No. : Hall B  
Stall No. : B5.32

### DATASOL BANGALORE PRIVATE LIMITED

Name : SATISH REDDY  
Phone : 9845186064  
Email : satishreddy@datasol-india.com  
Website : www.datasolindia.com  
Contact Person Name : SURESH KUMAR BS

#### Profile

Incepted in 1997 has been a pioneer in providing complete end to End solutions in embedded products for the Defense & Aerospace, Space and Private Establishments in India. Vision- to be the leading engineering and product Realization Company. We are MSME & AS 9100 RevD certified Company

Hall No. : Hall C  
Stall No. : C1.5,C1.6

### DCM SHRIRAM INDUSTRIES LIMITED

Name : Lalit Prasad  
Phone : 8448690982  
Email : lalitprasad@dcmsr.com  
Website : www.dcmshriramdefence.com  
Contact Person Name : Lalit

#### Profile

DCM Shriram Industries Ltd is into line manufacturing of Unmanned Aerial Vehicles. We have developed an easy to customise, scalable base platform with innovative touches which extend the performance capabilities. The UAV Systems have been designed to meet the stringent operational requirements of the Security Forces. They offer crash resistance, stable flight characteristics and up to 10% more flight time when compared to its competitors. It is a man pack scalable platform with less deployment time and can be customized based upon the application. The niche technology, aerodynamic shape and rugged composite material of the UAV, offers best in class speed and endurance. With Swappable Payloads it provides the flexibility to use the UAV for different applications such as Surveillance, Geospatial Mapping and Asset Inspections.

Hall No. : Hall B  
Stall No. : B5.9

### DEEP ENGINEERING INDUSTRIES

Name : Amandeep Singh Khinda  
Phone : 9815722443  
Email : info@deepenggind.com  
Website : www.deepenggind.com  
Contact Person Name : Amandeep Singh

#### Profile

Deep Engineering Industries is one of the prime aviation engineering firm established since 1999 exclusively for design, development and manufacture of aviation equipment both airborne and ground support. The firm has a most advanced technical infrastructure and multi-dimensional capabilities to undertake development and manufacture of any equipment involving structures, machining fabrication, pneumatics and fluid technologies.

Hall No. : Hall C  
Stall No. : C5.6

### DEEPALI DESIGNS AND EXHIBITS PRIVATE LIMITED

Name : Vinay Mittal  
Phone : 7838285539  
Email : vinay.mittal@deepalidesigns.com  
Website : https://www.deepalidesigns.com/  
Contact Person Name : Supriya Kumari

### Profile

Deepali Designs & Exhibits is a pioneer in the experiential communication industry, with an impeccable track for serving requirements related to organizing large scale events and exhibitions like the Commonwealth Games, customized event venue set up, make shift hospitals etc.

We carry with us the experience of over three decades in the industry, which has enabled us gather genuine command, in-depth know-how and adequate infrastructure for building customized modular structure. We have been able to set industrial benchmark in development of structures in an array of materials including- but not limited to- mild steel, aluminum, fiber, other metals & alloys for large-scale events.

Our dedicated R&D team helps us make the most of technological and engineering developments happening globally, by coming up with innovating solutions to real world problems and by means to improve the existing technologies. Our most recent project of building shelters that can be functional and can offer livable conditions in extremely cold regions is one example.

Headquartered in New Delhi, we proudly house one of the best and widest range of infrastructure backed by an amazing team of engineers, architects, executives and event managers for providing end-to-end solutions for any and all big-day need.

Hall No. : Hall H  
Stall No. : H5.7

### DEFENCE INVESTOR CELL

Name : SHRI K K YADAV  
Phone : 011-23019902  
Email : definvestorcell@ddpmod.gov.in  
Website : defenceinvestorcell.gov.in  
Contact Person Name : SHRI K K YADAV

### Profile

To promote Defence Sector manufacturing in India, in line with the Make in India initiative of the Government, there is a need to educate the investors about the opportunities available in Defence manufacturing Sector. To act as a single point of contact, a Defence Investor Cell is created under Department of Defence Production, Ministry of Defence, which will provide all necessary information including addressing queries related to investment opportunities, procedures and regulatory requirements for investment in the sector.

Hall No. : Hall D, CHALET  
Stall No. : D1 - 7, CHALET 25 - 28

### DEFENCE RESEARCH AND DEVELOPMENT ORGANISATION

Phone : 011-23011073  
Email : dpidrdo@hqr.drdo.in  
Website : www.drdo.gov.in

### Profile

Defence Research & Development Organization (DRDO) is the R&D wing of Ministry of Defence, Govt of India. DRDO is developing advanced defence systems for the armed forces and is working on the cutting edge technologies required for design & development of military equipment and soldier support systems. DRDO is working in the areas of Missile & Strategic Systems, Naval Systems & Materials, Aeronautical Systems, Armament and Combat Engineering Systems, Electronics & Communication Systems, Life Sciences, Microelectronic Devices & Computational Systems and Systems Analysis & Modelling. Over the past 60 years, DRDO has developed a vast range of defence products and systems, ranging from strategic missiles, tactical missiles, Surface to Air Missiles (SAM), Air to Air Missiles (AAM), Anti Tank Missiles, Anti Satellite Missile (A-SAT), family of Radars & Sonars for many platforms, Electronic Warfare (EW) systems, Main Battle Tank (MBT), Fighter Aircraft and many other systems required for Indian Armed Forces.

Hall No. : Hall C  
Stall No. : C1.11,C1.10

### DILABS SYSTEMS PRIVATE LIMITED

Name : Rajagopal Venkatesh  
Phone : 9845079138  
Email : venkatesh@dilabs.in  
Website : www.dilabs.in  
Contact Person Name : Rajagopal Venkatesh

### Profile

DILABS SYSTEMS PRIVATE LIMITED was incorporated in 2002 with the prime vision of making a significant contribution to the Avionics industry. Walking down the aisle of success, the company has hit several milestones that have paved the way for its monumental success towards achieving its vision. In the initial phase of its journey, the company began with design and development of Signal conditioning boards and gradually shifted to Complete Test Rigs for different Aircraft LRU's. This enabled the firm to take a giant leap as it exposed the team to the actual aircraft LRU's and the technology incorporated into these systems. Soon, the company began making some mock up units for an Aircraft simulator and designed Multifunction displays for an aircraft simulator. The company was involved in the design of the first IJT mock up for HAL which was showcased in one of the International Air Shows in Bangalore.

Hall No. : Hall E  
Stall No. : E5.2

### DIRECTORATE GENERAL OF AERONAUTICAL QUALITY ASSURANCE

Name : CHANDRASEKARAN ANNAMALAI  
Phone : 7905088731  
Email : dirac.dgaqa@gov.in  
Website : dgaeroqa.gov.in  
Contact Person Name : Virendra Kumar Mishra

### Profile

Directorate General of Aeronautical Quality Assurance (DGAQA) is an Organisation established in 1954 under Department of Defence Production, Ministry of Defence. DGAQA is the regulatory authority for Quality Assurance and final acceptance of Military Airborne stores, Armaments, Consumables (FOL Stores), Allied Ground Systems and Missiles during Design & Development, Production, Repair, Modification and Overhaul/ Repair at various Defence PSUs, Ordnance Factories, DRDO Labs and Private Firms. It also ensures QA requirements during acquisition of defence aeronautical stores by Ministry of Defence as per the provision of DAP & DPM. The primary role of DGAQA is to provide QA coverage under Approval of Firm and its Quality Management System (AFQMS) concept during various phases of the production/services viz Design & Development, Production, Up-gradation etc. DGAQA is also involved in Indigenisation and Standardisation activities. The other services rendered are Capacity Assessment & Registration of Firms and Test labs. Atmanirbhar Bharat Abhiyan and Make in India: The Government of India initiative on Atmanirbhar Bharat and Make in India program, many Indian vendors venture in to Indigenisation projects for Indian military aircraft industry posing a significant challenge to the QA function in general and regulatory organizations like DGAQA in particular. The task of DGAQA is becoming more elaborate and challenging in view of large number of associated work centres, spread far and wide, necessitating a large parallel efforts to monitor QA systems. There are 48 field establishments / offices spread all over the country which are located at various work centres. We are now looking for Global Cooperation in the field of Defence Aviation QA and as such keen to have International bilateral Agreements on providing QA services for Defence Aviation Stores.

Hall No. : Hall A  
Stall No. : A3.11

### DIRECTORATE OF STANDARDISATION

Name : Gp Capt Manoj Kumar Singh  
Phone : 01123 010464  
Email : oictechcoord.defstand@gov.in  
Website : www.ddpdos.gov.in  
Contact Person Name : Gp Capt MK Singh

### Profile

Directorate of Standardisation (DoS) is a nodal agency under MoD/DDP for Standardisation and Codification of Defence equipment with an aim to control item proliferation within the defence services by achieving entry control and variety reduction resulting in reduced inventory cost and is also the core agency for formulation of various types of Defence Services Standards for introduction of all new items. The tools used are in the form of Joint Service Specifications (JSS), Joint Services Rationalised Lists (JSRL), Joint Services Preferred Ranges (JSPR), Joint Services Guides (JSG) and Approval Notification (AN). The duties assigned to the Directorate is being met through the twin steps of Codification and Standardisation.

Hall No. : Hall F  
Stall No. : F3.2

### DR MGR EDUCATIONAL AND RESEARCH INSTITUTE

Name : Pandurengan D  
Phone : 9003413525  
Email : kamal.ari@drmgrdu.ac.in  
Website : <https://www.drmgrdu.ac.in/index.php>  
Contact Person Name : KAMALAHASAN

### Profile

“Knowledge Creation and Nation Building by Break Through Research to Solve Challenging Problems”

Hall No. : CHALET  
Stall No. : 37

### DYNAMIC TECHNOLOGIES LIMITED

Name : AJAY GURURAJ  
Phone : 9986077957  
Email : ajay.g@dynamics.net  
Website : www.dynamics.com  
Contact Person Name : Ajay Gururaj

### Profile

Dynamic Technologies Limited designs and builds highly engineered products for Automotive, Aeronautic, Hydraulic and Security applications. With futuristic design, engineering and manufacturing facilities in Europe and India, the company is able to meet customers' exacting requirements on 6 continent

Hall No. : Hall F  
Stall No. : F5.4

### EATON INDUSTRIAL PRODUCT PRIVATE LIMITED

Name : Ajit Kadwe  
Phone : 9765406115  
Email : ajitkadwe@eaton.com  
Website : www.eaton.com/in  
Contact Person Name : Ajit Kadwe

### Profile

Eaton is an intelligent power management company dedicated to improving the quality of life and protecting the environment for people everywhere. We are guided by our commitment to do business right, to operate sustainably and to help our customers manage power today and well into the future. By capitalizing on the global growth trends of electrification and digitalization, we're accelerating the planet's transition to renewable energy, helping to solve the world's most urgent power management challenges, and doing what's best for our stakeholders and all of society. Founded in 1911, Eaton has been listed on the NYSE for nearly a century. We reported revenues of \$19.6 billion in 2021 and serve customers in more than 170 countries.



Hall No. : Hall C  
Stall No. : C7.6

### ELBIT SYSTEMS

Phone : +972 77-2940000  
Email : marcom@elbitsystems.com  
Website : <https://www.elbitsystems.com>

#### Profile

Elbit Systems Ltd. is an international defence electronics company, engaged in a wide range of programs worldwide. The company operates in the areas of Aerospace, Land and Naval systems, C4ISR, UAS, Electro-optics and space systems, EW suites, Airborne Warning systems, ELINT, Data links, Military communications, Radios and Cyber-based systems. Elbit Systems operates as a worldwide organization, focusing the efforts both globally and locally in order to more effectively meet the needs of the customers around the world. Elbit systems solutions for Training & Simulation include School Management, Aircraft Service Provision, Logistics Services and Finance, all at best value to customers. Elbit Systems takes pride in its cooperation with local Indian Defence Industry leaders and has some prospering joint ventures with HAL, BEL, Bharat Forge, Alpha and Adani.

Hall No. : Hall F  
Stall No. : F1.14

### ELECTRONIC DIMENSIONS

Name : VENKEDUSAMY BANKARUSAMY  
Phone : 9481470071  
Email : bangarusamyv@gmail.com  
Website : [www.electronicdimensions.com](http://www.electronicdimensions.com)  
Contact Person Name : M ARUN KUMAR

#### Profile

The company is engaged in design and manufacturing of electronic equipment for the following sectors SPACE Air Force Process industries Medical electronics Communication sector The following products are designed and successfully. 1. Control warning Panel for Helicopter 2. Ice detector 3. Fuel level transmitter 4. Fire warning systems 5. Gyro Magnetic systems tester 6. PPU-UPP ARU Tester 7. UPP-GMK-COMPASS TESTER 8. KPVR3 - TEST SET 9. KPA-AGD-1- Gyro Horizon Tester 10. Meter Calibrator

Hall No. : Hall C  
Stall No. : C1.2

### ELECTRONICS CORPORATION OF INDIA LIMITED

Name : Srinivasa Rao B  
Phone : 9490611747  
Email : gmcdbm@ecil.co.in  
Website : <https://www.ecil.co.in/>  
Contact Person Name : DEBASMITA SAHU

#### Profile

Electronics Corporation of India Limited (ECIL), a Government of India Enterprise under the Department of Atomic Energy, was established in 1967 to primarily meet the control & instrumentation requirements of India's nuclear power program. Over the years, ECIL has diversified into other strategic sectors such as Nuclear, Defence, Security, Aerospace, Information Technology, Telecom & e-Governance. With self-reliance as its guiding beacon, ECIL pioneered a number of products and technologies. These include Solid State Television, Digital Computers, Cockpit Voice Recorders, Electronic Voting Machines, Programmable Logic Controllers, Earth Station and Deep Space Network Antennas. ECIL is widely recognized as a trailblazer in electronics and information technology in the country. ECIL firmly believes in supporting its customers throughout the life cycle of its products. and towards this end, maintains a nationwide network of marketing and service centers manned by experienced personnel.

Hall No. : Hall H  
Stall No. : H1.4

### ELECTROWING TECHNOLOGIES PRIVATE LIMITED

Name : Muthu Kumar M  
Phone : 9600202719  
Email : muthu@electrowingindia.com  
Website : [www.electrowingindia.com](http://www.electrowingindia.com)  
Contact Person Name : Muthu Kumar

#### Profile

Electrowing Technologies is an AS9100D certified company offers turnkey solutions for Embedded Computing to Environmental Control Systems for Defence and Aerospace applications.

Hall No. : Hall F  
Stall No. : F5.5

### ELETTRONICA SPA

Name : Alessio Barbati  
Phone : +3906 41541  
Email : alessio.barbati@elt.it  
Website : <https://www.elettronicagroup.com/>  
Contact Person Name : Alessio Barbati

### Profile

Founded in 1951 Elettronica is a world leader in the electronic defence sector. It currently supplies over 3000 systems to the governments of 30 countries on five continents and is involved in several major European defence programmes like the Eurofighter Typhoon combat aircraft. Elettronica's CY4GATE, specialises in cyber security and intelligence. Elettronica's, German subsidiary, Elettronica GmbH, is a European homeland security centre of excellence, EltHub is focused on research, innovation and fast prototyping.

Hall No. : Hall B  
Stall No. : B2.2b

### EMBRAER

Name : Paul Taylor  
Email : paul@rthgroup.co.uk  
Website : www.embraer.com  
Contact Person Name : Paul Taylor

### Profile

Embraer is a global company headquartered in Brazil with businesses in commercial and executive aviation, defense and security. The company designs, develops, manufactures, and markets aircraft and systems providing customer support and services. Since it was founded in 1969, Embraer has delivered more than 8,000 aircrafts.

Hall No. : Hall C  
Stall No. : C2.9

### ENSINGER INDIA ENGINEERING PLASTICS PRIVATE LIMITED

Name : Nikhil Tiwari  
Phone : 8007019944  
Email : n.tiwari@ensingerplastics.com  
Website : https://www.ensingerplastics.com/en-in  
Contact Person Name : Nikhil Tiwari

### Profile

Manufacturing of Plastic raw materials

Hall No. : Hall C  
Stall No. : C3.7

### ETERNUS PERFORMANCE MATERIALS PRIVATE LIMITED

Name : Rahul Pangre  
Phone : 9820604750  
Email : rahul@eternus.biz  
Website : www.eternus.biz  
Contact Person Name : Rahul Pangre

### Profile

Eternus is an AS9100RevD – Aerospace Certified – “End-to-End Design-to-Build” entity for Aerospace, Medical & Space sectors focusing on Mission Critical, Complex & Difficult to Realize” projects Its Focus Areas are Carbon Fiber and other Advanced Composites, Advanced Composite UAV Airframes (Micro, Mini, MALE, HALE, Target, Expendable, Multi Rotor and Fixed Wing), Assembly and Electro-Mechanical Integration Support for UAV Airframes, Precision Machined Titanium, Tungsten or Special Steel, Space Qualified Riveting & Bonding, Zero / Negative CTE Composite, Cryogenic Structural Composites, Lunar Lander & Rover Structural Composites and other mission critical applications. It supports OEMs in Design, Prototyping and Commercial Manufacturing of Critical Advanced Composites assemblies – including one-off prototyping too. Its Design expertise spans from Materials Characterization & Qualification including “A & B” Basis Design Allowables to Composite FEA, Layup Optimization, Composite Manufacturing and Curing Simulations – all the way to FAI. It also supports OEMs to migrate from Autoclave to “out of autoclave” products

Hall No. : Hall A  
Stall No. : A2.3

### EXICOM TECHNOLOGIES INDIA LLP

Name : Raghav Agarwal  
Phone : 9004243415  
Email : info@exicom.co.in  
Website : www.exicom.co.in  
Contact Person Name : Raghav Agarwal

### Profile

Exicom Technologies (India) LLP is an Indian company providing customised solutions in the field of covert operations, surveillance, perimeter security etc. For the Infrastructureless MESH MANET COFDM based communication solutions, Exicom Tech (I) LLP has an OEM support of Domo Tactical Communications, UK. In line with the Make in India initiative EXICOM can produce customised solutions for GARUD, MARCOS, PARA, NSG & all Special Commando Force, Perimeter Surveillance, Integrated surveillance solutions for Air Force Stations, Command and Control – Video cum Audio based.

Hall No. : Hall C  
Stall No. : C4.4

### EXPLEO TECHNOLOGIES INDIA PRIVATE LIMITED

Name : Venkataramana Mantha  
Phone : 08040367000  
Email : venkataramana.mantha@expleogroup.com  
Website : www.expleo.com  
Contact Person Name : Venkataramana Mantha

### Profile

Expleo is a global engineering, technology, and consulting service provider with focus on providing world-class engineering solutions to Aerospace & Defense, Automotive, Transportation and Industrial sectors. Expleo Group employs over 17,000 engineers across 30 different countries. Expleo is a key partner to some of the world's largest industrial groups: AIRBUS Group, IAI, Bombardier, Dassault Aviation, Rolls-Royce, ALSTOM, Spirit AeroSystems, General Electric, MTU, Stellantis, Renault, Thales, SAFRAN group, Schneider Electric and others. In India Expleo is providing game changing solutions to customers on a varied range of engineering & consultancy activities in Aerospace, Automotive, Transportation, Industrial, Banking and Insurance sectors. Expleo India team with more than 4300 strong engineers in Pune, Bangalore, Chennai, Mumbai and Coimbatore are supporting global and local customers in multiple areas of product development and manufacturing through the full life cycle activities of Design, Analysis, Technical Publications, Avionics Software & hardware Development, Verification & Validation, Industrialization activities.

Hall No. : Hall F  
Stall No. : F3.10

### FABHEADS AUTOMATION PRIVATE LIMITED

Name : Nivas Vallavan  
Phone : 9150034099  
Email : orders@fabheads.in  
Website : www.fabheads.com  
Contact Person Name : Sujithra P

### Profile

Fabheads is committed to bringing powerful and accessible fabrication tools into the creative hands of professionals in the industry. Starting out of ISRO in 2015, we are fundamentally a hardware start-up, comprising a passionate team of engineers, designers, and problem-solvers creating automation equipment to manufacture high-end carbon fiber parts. We are speeding up the transformation of manufacturing with 3D printing solutions for engineers, designers, and manufacturers in the industry. Fulfilling the real-world potential of additive, we have committed our company to applying 3D printers into the market with the brand name of FabMachines, delivering efficient and cost-effective integrated 3D printing solutions for individuals and enterprises. Having bagged several prestigious awards, they have earned a significant place in the industry. Top Startup in Manufacturing (2018), Outstanding Innovation in Composites Award (2019), Dare To Dream Award (2019) by DRDO, National Startup Award (2020) by Government

Hall No. : Hall C  
Stall No. : C2.11

### FDH AERO

Name : Pascale Pritchard  
Phone : +1213 620 9950  
Email : pascalle.pritchard@fdhaero.com  
Website : https://fdhaero.com/  
Contact Person Name : Raghavendra Prasad Mallaiah

### Profile

FDH Aero ("FDH") is a trusted global supply chain partner for aerospace and defense. With more than 55 years of experience, we specialize in hardware, electrical, chemicals, and consumable products and services for global OEM and Aftermarket customers. FDH is headquartered in El Segundo, CA, has operations across the Americas, EMEA, and Asia Pacific, and employs more than 1,000 people globally. Backed by Audax Private Equity ("Audax") since 2017, FDH Aero serves the Commercial Aerospace, Defense, Space, MRO, Airlines, Business Jet and Cargo markets. For more information, please visit FDHAero.com.

Hall No. : Hall H  
Stall No. : H4.8a

### FEDEX EXPRESS TRANSPORTATION AND SUPPLY CHAIN SERVICES (INDIA) PRIVATE LIMITED

Name : Valini Dsouza  
Phone :  
Email : valini.dsouza@fedex.com  
Website : www.fedex.com  
Contact Person Name : Valini Dsouza

### Profile

The FedEx strategy to compete collectively, operate collaboratively and innovate digitally provides a competitive advantage for our company. Our broad portfolio of services allows us to meet the needs of our customers, most of whom use services from two or more of our operating companies.

Hall No. : Hall H  
Stall No. : H2.6

### FOKKER ELMO SASMOS INTERCONNECTION SYSTEMS LIMITED

Name : Anjali Tripathi  
Phone : 8951858867  
Email : marketing@sasmos.com  
Website : www.sasmos.com  
Contact Person Name : Anjali Tripathi

### Profile

SASMOS HET Technologies Limited, a Bengaluru-based manufacturer and exporter of aerospace and defence technology solutions. SASMOS is a leading design and manufacturing company for Electrical Wiring Interconnection Systems,

Electromechanical assemblies & Electronic sub-systems for the Air, Land, Weapon, Marine, Space and Nuclear segments. SASMOS Defence Systems Division and Fibre Optic Division offer customized electronics, electrical, electro-mechanical mission-critical solutions and fibre optic interconnectivity products for harsh environment applications are the latest in the portfolio.

Hall No. : Hall F  
Stall No. : F3.5

### FORCE NEWS MAGAZINE

Phone : (0120) 4278691  
Website : www.forceindia.net

#### Profile

FORCE is an 80-page monthly print magazine (with an Internet edition www.forceindia.net) on national security: Defence, homeland and civil aerospace. FORCE focuses on the defence forces (Indian Army, Indian Air Force, Indian Navy and Indian Coast Guard); Defence Industries, both global and indigenous; Defence Research and Development Organisation; Procurements by Imports and Indigenisation; Emerging Technologies; Terrorism and Counter-Terrorism; Cyber and Future Warfare; Homeland Security and Paramilitary Forces; and Strategic and Geo-Political issues affecting India's security

Hall No. : Hall F  
Stall No. : F3.8,F3.7

### FLIGHT SIMULATION TECHNIQUE CENTRE

Name : Shikhin Pawar  
Phone : 9871101630  
Email : shikhin.pawar@fstc.in  
Website : www.fstc.in  
Contact Person Name : Shikhin Pawar

#### Profile

Flight Simulation Technique Centre (FSTC) is the most advanced and largest Full Flight Simulation training company in India today. We are India's first standalone Approved Training Organization (ATO) by DGCA and the only approved ATO by European Aviation Safety Agency (EASA). FSTC today has various simulator types to fulfil the diverse requirements of majority of the airlines in India and adjoining regions. Today, with 10 fully operational level D simulators, we have presence at 2 locations within the country; Gurugram and Hyderabad. FSTC Flying School is our new venture, initiated with a vision of providing comprehensive pilot training services to the budding Flyers. It is envisioned to be the largest Flight Training School in the region which will boast of state-of the art infrastructure such as brand-new Trainer Aircraft, Unrestricted Airspace ensuring Continuous Flying, Proximity to DEL/NCR region, Quality Flying Instructors and International Training Curriculum. FSTC has capability to integrate and manufacture Full Flight Simulators for all types of aircraft/helicopters being flown in the Armed Forces under Make II on Build, Operate, Maintain and Pay & Use basis. We can provide High value Simulator solutions with low capital & operational risk to the Armed forces under 'Make in India' & 'Atma Nirbhar Bharat initiative of GOI

Hall No. : Hall B  
Stall No. : B5.5

### FUTURE METALS LLC

Name : PRASAD NN  
Phone : +1(800) 733 - 0960  
Email : prasad@futuremetals.com  
Website : www.futuremetals.com  
Contact Person Name : Prasad NN

#### Profile

Future Metals is a distributor offering wide range of Products & Services for Defense/ Commercial / Military Aerospace MRO & Manufacturing segment. \* Our range of products includes Tubes, Bars, Sheets, Extrusions & Roll Forms made from various metals like Aluminium, Steel, Titanium & Special Alloys. \* We support Global OEMs, Tier1s & Tier2s from our 11 Global stocking locations in India (1 location), Singapore (1 location), Europe (UK, Netherlands, Poland - 3 locations), USA (6 locations). Future Metals in recent times have added product capabilities in below: •Aviation MRO with Cabin Interior Plastics with a global sole distribution agreement with ACI, UK. •Fluid Flow Control Products (Fittings/Flanges/Seals/Couplings & Toolings etc – Future Metals owned distribution company – “ORKAL Inc”, USA). •Aviation Hoses or Aerospace Hoses – Future Metals owned distribution company – “Aero Hoses”, USA (Ref www.aero-hose.com ) Keep an eye on this space for more products & services that will be added in future. We look forward to your enquiries in Metals, Plastics, Fittings & Hoses.

Hall No. : Hall A  
Stall No. : A4.3

### GARG ASSOCIATES PRIVATE LIMITED

Name : RAHUL SINGH  
Phone : 9867163213  
Email : rahul.singh@gargasso.com  
Website : www.gargasso.com  
Contact Person Name : ANITA

#### Profile

Garg Associates Pvt. Ltd. established in 1966, is a Designer and Manufacturer of High Performance Wires and Cables. We support Defense, Aerospace, Navy, Medical, Automotive, industries. GAPL is Mil qualified and QPL listed AS9100 Rev D certified company. GAPL is supplying cables to major Global and Indian Aerospace OEMs including Boeing. GAPL's Testing Lab is ISO 17025 (NABL accredited) and conducts all the tests of AS 22759. Garg Associates produce Manufacturer of PI-PTFE Insulated Wires & Cables, Fluoropolymer wires, High Voltage Wires & Cables, Multicore Cables, Equipment Wires, RF Coaxial Cables, Flat Cables, PTFE/FEP Insulated Thermo Couple & RTD Wires, PTFE Sleeves/Tubings, High Speed Light weight Data Cables for Aerospace Applications. Whether it is a custom design or a standard product, there is a solution to the most demanding environment and application.



Hall No. : Hall G  
Stall No. : G3.4

### **GENSER AEROSPACE AND IT PRIVATE LIMITED**

Name : sathyavathi v  
Phone : 080 2237 0417  
Email : arunakar.mishra@genser.com  
Website : ARUNAKAR MISHRA  
Contact Person Name : v Sathyavathi

#### **Profile**

Aerospace Design, Manufacturing and Aviation Services

Hall No. : Hall B  
Stall No. : B3.2,B4.1,B4.2

### **GIFAS**

Name : Corinne BOSSELUT  
Phone : +33 1444 31700  
Email : corinne.bosselut@gifas.fr  
Website : www.gifas.fr  
Contact Person Name : Corinne BOSSELUT

#### **Profile**

GIFAS (the French Aerospace Industries Association), created in 1908, is an industry body that brings together over 400 companies ranging from the main prime contractors and system suppliers to SMEs.

Hall No. : Hall G  
Stall No. : G2.6,G2.7

### **GLENAIR INC**

Name : Padmanathan Vasudevan  
Phone : +1818 247 6000  
Email : padhu@glenair.com  
Website : www.glenair.com  
Contact Person Name : Padmanathan Vasudevan

#### **Profile**

Glenair manufactures high-reliability connectors and cables for mission-critical land, sea, air, and space applications. The company began operations in 1956 producing electrical connector backshells and accessories.

Hall No. : Hall E  
Stall No. : E.5.4

### **GLIDERS INDIA LIMITED**

Name : Konan Kumar Toppo  
Phone : 8765595534  
Email : kktoppo@ord.gov.in  
Website : glidersindia.in  
Contact Person Name : Konan Kumar Toppo

#### **Profile**

Gliders India Limited is Govt. of India undertaking incorporated on 01st October 2021 as Government Owned Defence Public Sector Undertaking. Earlier it was under OFB known as Ordnance Parachute Factory, a Defence Production Unit of Government of India. Which was evolved to become the manufacturer of Parachutes catering to the diverse requirements of the Indian Armed Forces and the MHA. Our team excels at producing a wide variety of parachutes, including Man carrying Parachutes, Supply Drop Parachutes, Brake Parachutes, Parachute components and accessories. We also manufacture KM Floats, Inflatable Boats and various lifecycle items for our soldiers, rigorously adhering to the quality standards required at battlefronts. We cater to the demands of Indian Army, Navy, Air Force, Indian Coastguard, ITBP, State Police Forces among others including many International Customers.

Hall No. : Hall H  
Stall No. : H2.4

### **GLODESI TECHNOLOGIES PRIVATE LIMITED**

Name : sukesh kukkehalli  
Phone : 9900954847  
Email : sukesh.k@glodesi.com  
Website : www.glodesi.com  
Contact Person Name : Sukesh K

#### **Profile**

Glodesi Technologies is a global sourcing company based in India and is a one stop shop for global OEM's in Aerospace, Defense and Medical Equipment sectors for precision mechanical parts, products and assemblies for critical Aerospace and Defense applications. Being an AS 9100 certified company, Glodesi has in a short span of time carved a reputation for quality, cost efficiency and timely delivery of critical products to International customers. Glodesi has been recognized as a Global Sourcing provider by leading Aerospace and Defense manufacturing companies in US, Israel and emerging vibrant markets around the world.

Hall No. : Hall B  
Stall No. : B2.2c

### **GODREJ & BOYCE MANUFACTURING COMPANY LIMITED**

Name : Ramesh Kumar Sankaran  
Phone : 9819646538  
Email : srkn@godrej.com  
Website : <https://www.godrej.com/aerospace-and-defence>

#### **Profile**

Godrej Aerospace (GA), a business unit of Godrej & Boyce Mfg. Co. Ltd. under Industrial Products group is engaged in the Hi-Tech Aerospace manufacturing activities. Our foray into aerospace activities started with development of critical, high precision spacecraft components, made out of exotic alloys in 1985. Currently we are executing major Aerospace projects which serve the Defence, Space and Aircraft Segments. The projects undertaken involve Precision machining, Precision fabrication, Complex Tubes & Ducts, Line Replaceable Units (such as Actuators, Valves, Pumps, Accumulators, Filters), Composite and Rubber parts, Assembly (Mechanical, Welded & Rivetted), Testing & Supply of Complex & Airworthy Systems. We have also recently forayed into build to spec opportunities for Defence under the prestigious Atmanirbhar Bharat Program of Government of India. Our certifications include AS 9100 Rev D, ISO 27001 and NACAP in Chemical Processing, Heat Treatment & Brazing, Welding, NDT, Composites, Elastomer Seals, CMM, Laser Cutting, EDM.

Hall No. : Hall F  
Stall No. : F6.3

### **GOPALAN AEROSPACE INDIA PRIVATE LIMITED**

Name : Deepthi Antony  
Phone : 6364569514  
Email : ps@gopalanenterprises.com  
Website : Gopalan Foundation  
Contact Person Name : Deepthi

#### **Profile**

Gopalan Aerospace is a fast-paced, innovative ISO 9001/AS 9100 Rev D 2015 certified, Aerospace Components and Composites Design, Development, and Manufacturing Company. Our clients include some of the largest names in the Aerospace and Defence Industry. With 10.5 acres of land and 1,50,000 sqft. of built-up, Gopalan Aerospace aims to become a center of excellence in Precision Components, Machining, Fabrication, and Assemblies in the Aerospace and Allied Sectors. Gopalan Aerospace is a leader in Active and Passive Radars, Aerial Targets, Drones and UAV's for the Indian Defence Sector. Our Expertise Precision Component Machining & Sub-Assembly CNC Machining 3 Axis to 5 Axis Components for Defence Industry Light & Heavy Engineering Robotic Welding Machining Steel Sheet Rolling, High Pressure Testing Aircraft Interiors Seat Back Trays, Arms Rests, Luggage Bin, Doors, Repair & Overhaul Composites Composite parts of Aerospace Application Any Size up to 7mtrs, including Glass Fiber, Carbon Fiber & Kevlar Our Divisions · Tooling · Conventional Machining · CNC Milling and Turning · Quality Control ·Sub-Assemblies and Assemblies

Hall No. : Hall E  
Stall No. : E5.5

### **HARYANA AIRPORT DEVELOPMENT CORPORATION**

Name : Daljit Singh  
Phone : 0172 - 2709386  
Email : daljitsingh.cavn@hry.gov.in  
Website : <https://haraviation.gov.in/>  
Contact Person Name : Daljit Singh

#### **Profile**

Haryana Airports Development Corporation Ltd. is envisaged to be incorporated as a Government Company. The main objectives of the Haryana Airports Development Corporation Ltd is to manage, regulate the establishment and implement the airport projects/joint-venture projects of the Government of Haryana for the purpose of establishing and operating Integrated Aviation Hub at Hisar and other airfields of the Haryana.

Hall No. : Hall F  
Stall No. : F3.1

### **HC ROBOTICS**

Name : Dileep Vakulabharnam  
Phone : 09398574866  
Email : dileep.v@hcrobo.com  
Website : HC Robotics Private Limited  
Contact Person Name : Dr Dileep Vakulabharanam

#### **Profile**

The company has acquired a manufacturing licence for Drones and Gyro Stabilized Gimbal controlled EOIR (Electro-Optical/Infrared) cameras with thermal and visual sensors

Hall No. : Hall A  
Stall No. : A8.5

### **HICAL TECHNOLOGIES PRIVATE LIMITED**

Name : Neeraj R  
Phone : 7022337792  
Email : neeraj.r@hical.com  
Website : [www.hical.com](http://www.hical.com)  
Contact Person Name : Rajesh K

#### **Profile**

Hical Technologies, India is a 33 year old company headquartered in Bangalore, India. We have a team of over 800 members, a 100% exporter of Motors, Solenoids, Transformers and Systems Integration (Box builds, Cable harness & Wiring integration, Mechanical integration, Navigation Consoles integration) products for Aerospace, Military, Medical and Automotive. We have two subsidiaries : 1. Yagachi Technologies Hassan unit Feeder to Hical for Avionics parts and 2. Yagachi Technologies Chennai unit manufacturer for Auto Industry. We have a space of 33 acres, 200,000 sq ft of manufacturing space. We supply directly to Raytheon Technologies (we are a United Technologies Gold

Supplier for 10 years), Boeing-Test and Evaluation Division, Thales, Transdigm Group, Eaton, Honeywell, Moog, Crane, TE, Milton Roy and more. We are vertically integrated with in-house Precision Machining, Mechanical Assembly (Nadcap), Winding, Testing and Special Processes and also, we have Inhouse Technology Development centre for Built to Spec designs.

Hall No. : Hall H  
Stall No. : H3.2

### HILD DEFENCE AND AEROSPACE PRIVATE LIMITED

Name : Karthickeyan N  
Phone : 9841616760  
Email : marketing@hildad.com  
Website : WWW.HILDAD.COM  
Contact Person Name : Karthickeyan N

#### Profile

HILD Defence and Aerospace Pvt Ltd is a wholly owned vertical of the Eagle group of businesses. We are registered with the Confederation of Indian Industries (CII) and are located in Tamilnadu India. We have embarked on design-develop-integrate-fabricate-manufacture of equipment for Counter Unmanned Systems (C-UAS), Unmanned systems for general/agriculture/military/logistics applications, and such similar items required for defence and homeland security. We have adequate manufacturing capacities for Indian as well as regional demands.

Hall No. : Hall A  
Stall No. : A3.10

### HIMANSHI THERMAL SOLUTIONS

Name : Anil Babu  
Phone : 9986383353  
Email : anil@hitherms.com  
Website : www.hitherms.com  
Contact Person Name : Anilbabu

#### Profile

Thermal Solutions provider have got an expertise in manufacturing of compact heat exchangers, cold plates, enclosures & others

Hall No. : Hall B  
Stall No. : B5.8

### HIND SALES CORPORATION

Name : Satinder Kaur  
Phone : 9814042722  
Email : dei\_aman@yahoo.com  
Website : NA  
Contact Person Name : Charanjit Singh

#### Profile

We are a leading company in aviation sector. Our specialization are aviation containers, aviation packing cases, special fixtures, ground support equipment and lashing material.

Hall No. : Hall E, CHALET & OUTDOOR  
Stall No. : E.2.1 - 2.4, Chalet.21 - 24, OD.01 - 02

### HINDUSTAN AERONAUTICS LIMITED

Name : ARUP KUMAR MALLICK  
Phone : 9740317883  
Email : marketing@hal-india.co.in  
Website : https://hal-india.co.in/  
Contact Person Name : ARUP KUMAR MALLICK

#### Profile

Hindustan Aeronautics Limited (HAL), a Navratna Defence Public Sector Undertaking under Ministry of Defence, Government of India is a premier aeronautical complex in Asia with 20 Production Divisions and 10 R&D centers situated across India. HAL's expertise encompasses Design, Development, Manufacture, Maintenance, Repair, Overhaul, Upgrade of Fighter, Transport, Trainer Aircraft, Helicopters, Aero-engines, Accessories, Avionics and Systems. HAL had a sales turnover of US \$3 Billion (INR 24,000 Cr) during FY 2021-22. HAL today provides one stop solution for Design, Development, Manufacture, Upgrade and Maintenance of Aerospace Equipment viz. Fixed & Rotary Wing Aircraft, Engines, Structure for Space Vehicles etc. The current projects of HAL include manufacturing of LCA Tejas, ALH Dhruv & its variants, Do-228 (Multi-Mission), Mid-Life Upgrades for Mirage, Do-228 and Jaguar Darin III aircraft etc.

Hall No. : Hall F  
Stall No. : F4.1

### HINDUSTAN INSTITUTE OF TECHNOLOGY AND SCIENCE

Name : Dr Asokan R  
Phone : 09884136822  
Email : deanaero@hindustanuniv.ac.in  
Website : Hindustan Institute of Technology and Science

Contact Person Name : Dr R Asokan

#### Profile

HINDUSTAN INSTITUTE OF TECHNOLOGY AND SCIENCE (HITS), is a leading prestigious and recognized institution in India, located at Chennai, Tamil Nadu, commenced in 1985, it offers a wide spectrum of undergraduate, postgraduate, diploma, research, and doctoral programmes in diverse fields of engineering, technology, architecture, management, law, fashion design, aviation, applied sciences, allied sciences and arts & sciences. The technical courses at UG and PG levels are approved by AICTE. NBA has certified seven undergraduate programmes offered Aeronautical Engineering, Aerospace Engineering, C computer Science Engineering, Electronics and Communication Engineering, Electrical and Electronics Engineering, Mechatronics Engineering & Information Technology under Tier I Category. HITS are a part of most illustrious Hindustan Group of Institutions well known for aviation caters to academic needs of 15,000 students

Hall No. : Hall B  
Stall No. : B5.26

### HI-REL TECH PRIVATE LIMITED

Name : Santhosh MB  
Phone : 09880938698  
Email : marketing@hi-reltech.in  
Website : www.hi-reltech.in  
Contact Person Name : Deepak

#### Profile

Hi-Rel Tech is a supplychain solutions provider that delivers comprehensive design, manufacturing, supplychain and product management services for a wide array of industries. Hi-Rel Tech Private Limited was established in 1998 as a supply chain consultant. Our global supply chain as well as our manufacturing team led by senior managers with more than 25+ years of experience. Our strategic alliances with technology and supply chain partners across the globe enable us to provide our clients, the best cost-effective and tailored solutions.

Hall No. : Hall G  
Stall No. : G4.2

### HTL LIMITED

Name : Rishikesh Doijode  
Phone : 8867687857  
Email : sajan.tom@htllimited.com  
Website : https://htllimited.com/  
Contact Person Name : Rishikesh Doijode

#### Profile

HTL Ltd is an AS 9100 accredited company which caters to Build-to-Print Electrical Wiring Interconnect Solutions for Aerospace & Defence Segments. Our competencies spans across Fiber Optics, Passive Connectivity Solutions which extends into Electrical Wiring Interconnect Solutions for Air, Land & Sea. Our manufacturing facilities as located at Chennai & Hosur have a total manufacturing space of around 30,000 sq.ft with an annual capacity of building more than 8000 cable assemblies and box builds per annum which is scalable to more than a lakh sq.ft in a short time.

Hall No. : Hall B  
Stall No. : B5.17a

### HYPERCOAT ENTERPRISES PRIVATE LIMITED

Name : Hassan Bin Othman  
Phone : +65 6542 8989  
Email : hassan@hypercoat.com.sg  
Website : www.hypercoat.com.sg  
Contact Person Name : Geeta Ramchandran

#### Profile

Hypercoat Group is authorized distributors of aircraft parts and material, specializing in aerospace coatings, composites, chemicals, and airframe and engine system spares. We provide product and technical support to our aviation customers from 14 offices and warehouses located world wide.

Hall No. : Hall G  
Stall No. : G1.7

### HYT INOVATIVE PROJECTS PRIVATE LIMITED

Name : Eknath Pethe  
Phone : 8956914748  
Email : marketing.mngr@hyaerospace.com  
Website : www.hyaerospace.com  
Contact Person Name : Eknath Pethe

#### Profile

HYT INOVATIVE PROJECTS PVT LTD (HIPPL) an ISO 9001: 2015 certified company, established in 2001 with manufacturing of PINAKA MOTOR TUBE for Ordnance factory Ambajhari and THIN WALL TUBE for Bhabha Atomic Research Centre. Furthermore, we added five numbers of flow forming machines, and expanded our manufacturing capacity to fulfil wide range of sizes from min diameter 50 mm to max diameter 650 mm, thickness 0.4 mm to 6 mm and maximum length 3.5 mtr. We at HIPPL have associated technologies related to rocket motors such as EPDM Lining, Silica Phenolic lining, Fibre Glass Reinforced Moulding along with flow forming. HIPPL has unique privilege in contributing to the needs of the Defence Forces and other institutions such as Bhabha Atomic Research Center, Bharat Dynamics Limited, DRDL, RCI, ARDE, HEMRL, and various Ordnances Factories. Our Company spread over the area of 4423 Sqm, is an MSME located at Pune, India. We have 90 Nos of workers and 40 Nos of staff including 10 Nos Engineers. We have a set-up of inspection and testing facility to meet stringent defence quality control requirements, As on toady we have supplied, 15000 Nos Pinaka Motor Tubes, 1000 Nos LRSAM/MRSAM Tubes, and 300 Nos, Brahmos B2 Motor Shells meeting stringent norms and the required standards."

Hall No. : Hall E & CHALLET  
Stall No. : E.5.1,CHALET.13 - 16

### INDIAN AIR FORCE

Name : Indian Air Force  
Phone : 01123 063411  
Email : dopsmpr@iaf.nic.in  
Website : INDIANAIRFORCE.NIC.IN  
Contact Person Name : WG CDR PALLAVI PONNAPPA

Hall No. : Hall H  
Stall No. : H5.6

### INDIAN INSTITUTE OF MANAGEMENT BANGALORE (IIMB)

Name : Mohsina Jabeen  
Phone : 8105097734  
Email : mohsina.jabeen@iimb.ac.in  
Website : iimb.ac.in  
Contact Person Name : Mohsina Jabeen



### Profile

The Indian Institute of Management Bangalore (IIMB) is a leading graduate school of management in Asia. Under the IIM Act of 2017, IIMB is an Institute of National Importance.

Hall No. : CHALET  
Stall No. : CHALET 17, 18

### INDIAN NAVY

Phone : 9168294449  
Email : [dnas@navy.gov.in](mailto:dnas@navy.gov.in)

Hall No. : Hall A  
Stall No. : A2.6

### INDO AEROSPACE SOLUTIONS PRIVATE LIMITED

Name : Ajay Singh  
Phone : 9711113999  
Email : [ajay@indo-aerospace.com](mailto:ajay@indo-aerospace.com)  
Website : [www.indo-aerospace.com](http://www.indo-aerospace.com)  
Contact Person Name : Ajay Singh

### Profile

Indo Aerospace Solutions is a leading Indian aerospace materials distributor with vast inventory of Aluminium, Stainless Steel, Titanium, Nickel Alloy products in most of the existing forms. The company offers a targeted support and tailored supply chain services to world's leading Aerospace and Defence companies. We provide a Global multi-metal supply source for the Aerospace and Defence industry. Aerospace approvals (AS9120:2016) demonstrate our quality commitment.

Hall No. : Hall H  
Stall No. : H3.4

### INDO WINGS PRIVATE LIMITED

Name : Paras Jain  
Phone : 9837682451  
Email : [himanshu@indowings.com](mailto:himanshu@indowings.com)  
Website : [www.indowings.com](http://www.indowings.com)  
Contact Person Name : Himanshu Mishra

### Profile

Indo Wings Private Limited is a leading manufacturer of Advanced Unmanned Aerial Vehicles (UAVs) & Anti-UAVs. Pioneer in providing services for various industries and setting high standards in advancements of aerospace technology. Our expert-led R&D team develops a wide range of market-leading Drones and Anti-Drone Systems. We are technical experts, in the successful application of GIS solutions for multiple sectors. We are located in

Noida, Uttar Pradesh, India, with a state-of-the-art manufacturing facility. Our expert-designed UAV Series, along with the user-friendly Post-Processing Software, are so developed for swift and dynamic operations with real-time expeditions, 2D/3D/4D GIS mapping, geospatial data-processing, security, surveillance, monitoring, inspection, multi-mission reconnaissance capabilities, BVLOS drone control, swarming capabilities, and can also be integrated into various other customizable use cases.

Hall No. : Hall F  
Stall No. : F5.6, F6.6

### INDO-GERMAN CHAMBER OF COMMERCE

Name : Sonia Prashar  
Phone : +91 9810152363  
Email : [sonia.prashar@indo-german.com](mailto:sonia.prashar@indo-german.com)  
Website : [www.indo-german.com](http://www.indo-german.com)  
Contact Person Name : Sonia Prashar

### Profile

Bilateral Chamber promoting economic cooperation between India and Germany. Established in 1956 with head office in Mumbai and regional offices in Delhi, Bangalore, Chennai, Kolkata, Pune and representative office in Duesseldorf.

Hall No. : Hall A  
Stall No. : A1.10

### INNOVATION COMMUNICATIONS SYSTEMS LIMITED

Name : Karan Satav  
Phone : 9545599823  
Email : [karans@icsglobal.biz](mailto:karans@icsglobal.biz)  
Website : <http://icsglobal.biz/>  
Contact Person Name : Karan Satav

### Profile

Innovation Communications Systems Ltd. (ICS) is a product development company that supports organizations to bring highly technical products and services to market in the area of Signal Processing for Communications, Radars (wide range of frequency bandwidth 3 MHz to 60 GHz) & Image Processing. Through its continuous R&D efforts, ICS is pushing the boundaries for delivering field deployable end-to-end solutions specific to customer needs for applications across commercial, public and defence sectors. ICS's Flagship products are Software Defined Radio, High Capacity Radio Relay (& LWRR), Digital Mobile Radio and DVB-S2/RCS Satcom Modem. ICS has also delivered several sub systems in the areas of; Transmitters | Receivers | RF & Microwave Products (S to Ka Band) | Embedded/VLSI | Baseband System Design | Networking Systems | Digital Audio | Video and Data Recorders | SATCOM (DVB-SH, S2 and RCS) | Image Processing & Computer Vision | ADAS.

Hall No. : Hall F  
Stall No. : F1.11

### **INTEGRAL SYSTEMS AND COMPONENTS PRIVATE LIMITED**

Name : S SRINIVASAN  
Phone : 9972561405  
Email : inty.systems@gmail.com  
Website : www.integralsys.in  
Contact Person Name : Venkatesh. K

#### **Profile**

INTEGRAL SYSTEMS AND COMPONENTS PVT LTD is one of the leading ISO 9001:2015 certified manufacturers, suppliers and exporters of MIL Grade, Professional Grade Switches and Electro Mechanical components that are widely used in Telecommunications, Industrial and Defence applications. The company was established in the year 1979 and since then the company's strengths have been in the area of Research and Development and Engineering Design. The company has an excellent tooling facility which is the backbone of any component industry. Documentation is given maximum priority with a very good feed back system from Marketing and Production for continuous improvement in the Products and Services Apart from the above, the company excels in customising the standard products to meet the customer's requirements and specifications. The company also assists in re-designing and indigenising product requirements

Hall No. : Hall B  
Stall No. : B5.12

### **INVESTMENT & PRECISION CASTINGS LIMITED**

Name : Ankit Gohel  
Phone : 9227962037  
Email : npd@ipcl.in  
Website : www.ipcl.in  
Contact Person Name : Ankit Gohel

#### **Profile**

IPCL since 1975 is the manufacturer of Investment castings (Ferrous and Non Ferrous) for segments including Aerospace & Defence. We supply parts having application in Aero Engine, Cryogenic Engine, Gas Turbine, Military Tanks, Locomotives, Flight Control Apparatus, Electronic Circuit Housing, Night Vision Mountings, Light Machine Gun, Assault Rifles, and Torpedo Launchers etc. We can handle almost all the Ferrous and Non Ferrous Material specifications like IN718, IN713, IN738, BZL12Y, CM247, X40, F75, FV507, CF3, CF3M, CF8, CF8M etc. We have dedicated ASD plant having special facilities like "Hot Isostatic Press", "Vacuum Induction Melting", and Aluminium Melting & Heat Treatment. We have NABL accredited facilities for the Chemical, Mechanical and Metallurgical Testing. We have NADCAP approval for the NDT – FPI & MPI Our management systems have been qualified according to DGAQA, EN 9100:2018, ISO 9001:2015, IATF 16949:2016, ISO 14001:2015, ISO 45001:2018, PED 2014/68/EU & AD 2000-Merkblatt W0 Certified By TUV-Nord.

Hall No. : Hall F  
Stall No. : F5.1,F5.2

### **ISRAEL AEROSPACE INDUSTRIES LIMITED**

Name : JYOTI BHASIN  
Phone : 9810770740  
Email : jyoti-in@iaiworld.co.il  
Website : WWW.IAI.CO.IL  
Contact Person Name : JYOTI BHASIN

#### **Profile**

IAI is a leader in defense, aerospace, and commercial markets. IAI leverages state-of-the-art technology and decades of combat-proven experience delivering solutions to your national defense and security challenges. We offer a vast portfolio producing air and missile defense, unmanned aerial systems (UAS), ground robotics, precision-guided weapons, and loitering munitions. We deliver special-mission aircraft, modernize military aircraft and helicopters, and convert passenger jets into cargo aircraft through modification, conversion, and system integration. Our technology expertise features systems and solutions from reconnaissance satellites and radars to all aspects of command, control, and communications, computing and cyber, intelligence, surveillance, and reconnaissance systems (C5ISR). We fully support India's vision of "AtmaNirbhar Bharat" as part of our long-lasting partnership and commitment.

Hall No. : Hall F  
Stall No. : F2.5

### **JAS PROPAC INC**

Name : JEANPAUL VICTOR  
Phone : 9632280866  
Email : jean@propac.co.in  
Website : WWW.PROPAC.CO.IN  
Contact Person Name : JEANPAUL VICTOR

#### **Profile**

We JAS ProPac Inc., for the past 6 years are engaged in manufacturing of Dunnage Air Bags. We also provide complete packaging solutions as per the Industry requirement. We supply the various packing material through out India and also export.

Hall No. : Hall A  
Stall No. : A3.8

### **JAYEM TRADE PRIVATE LIMITED**

Name : Shobha M  
Phone : 8105687739  
Email : accounts03@jayemtrade.in  
Website : www.jayemtrade.in  
Contact Person Name : Sunil Rampore

#### **Profile**

Jayem Trade Pvt Ltd is a importer and distributor for Magnesium AZ31 and Elektron 43 plates and other Magnesium Alloys.



Hall No. : Hall F  
Stall No. : F2.6

### JISNU COMMUNICATIONS PRIVATE LIMITED

Name : Gulab Singh  
Phone : 7995011895  
Email : gulabsingh@jisnu.com  
Website : www.jisnu.com  
Contact Person Name : Gulab Singh

#### Profile

JISNU Communications is a specialized engineering company committed to developing & manufacturing advanced strategic communication solutions for the Space & Defense sectors across Ground, Marine and Airborne platforms

Hall No. : Hall C  
Stall No. : C4.6

### JJG AERO PRIVATE LIMITED

Name : Anuj Jhunjunwala  
Phone : 9650976901  
Email : anuj@jjgmachining.com  
Website : www.jjgmachining.com  
Contact Person Name : Anuj Jhunjunwala

#### Profile

Engaged in the manufacture of precision machinings with inhouse special processes. Been serving Tier-1 & OEM clients like Collins, Safran & Boeing for more than 15 years now

Hall No. : Hall G  
Stall No. : G3.1

### JNR AEROSPACE INDIA PRIVATE LIMITED

Name : Abhishek Iyer  
Phone : 9953358343  
Email : info@jnraerospace.in  
Website : www.jnraerospace.in  
Contact Person Name : Abhishek Iyer

#### Profile

An MRO company serving aviation customers around the world

Hall No. : Hall H  
Stall No. : H2.1

### JSC IT CONCEPTS INDIA PRIVATE LIMITED

Name : Sunil Agrawal  
Phone : 9910444961  
Email : info.india@itcworld.com  
Website : www.itcworld.com  
Contact Person Name : Sunil Agrawal

#### Profile

We M/s. JSC IT CONCEPTS India Pvt Ltd. take pleasure in introducing ourselves as a world's leader in manufacturing of Industrial Borescope / Endoscopes/ Videoscope used by many Industries for the various inspection purposes. Also, we wish to inform you that our INDUSTRIAL ENDOSCOPES / BORESCOPES/ VIDEOSCOPIES are now being widely used by all type of Industries such as, Aviation, Automobile, Chemical, Steel, Refineries, Thermal Power Plants, Diesel engines, , Fertilizer, Food & Process industry, Special application purposes etc.

Hall No. : Hall C  
Stall No. : C2.6,C2.7,C2.8

### KALAPURNA STEEL & ENGG PRIVATE LIMITED

Name : Paul Manjaly  
Phone : 9004655667  
Email : marketing@kalapurna.com  
Website : www.kalapurna.com  
Contact Person Name : Paul Manjaly

#### Profile

We are one of the leading AS9120 certified stockist and distributors of all ferrous, non-ferrous raw materials required for the Aerospace & Defense Industry. We supply in various these items in various forms like Sheets, Plates, Flat bars, Round Bars, Forgings, Billets, Pipes, Tubes etc. We also supply material cut to customer required sizes.g

Hall No. : Hall A & CHALET  
Stall No. : A4.4,A4.5,A5.1,A5.2,A5.3,  
A6.3,A7.2,CHALET.32

### KALLMAN WORLDWIDE INC

Name : Carolyn Carniaux  
Phone : +120 1251 2600  
Email : carolync@kallman.com  
Website : www.kallman.com  
Contact Person Name : Mike Petrassi

### Profile

USA Pavilion Organizer

Hall No. : Hall C  
Stall No. : C5.3

### KALYANI RAFAEL ADVANCED SYSTEMS PRIVATE LIMITED

Name : Virath Nair  
Phone : 9100773105  
Email : virath.nair@kras.co.in  
Website : <https://www.krasindia.com/>  
Contact Person Name : Virath Nair

### Profile

Kalyani Rafael Advanced Systems Pvt. Ltd. (KRAS) is an Indian company and a Joint Venture bringing engineering expertise of Kalyani Group, INDIA and Technology & System expertise from Rafael Advanced Defence Systems Ltd., ISRAEL. KRAS has been established at Hyderabad which is the nerve centre for weapon system development, It is equipped with the world class Reliability testing facility establish to address electronics manufacturing and system integration as per military standards (MIL-STD-810). KRAS has State-of-the-art engineering, manufacturing & testing facilities required for technology systems. KRAS is certified "SECRET" facility to undertake sensitive defence projects for the Indian & Israel MOD.

Hall No. : Hall F  
Stall No. : F4.5

### KAPASI-SOUTHCO INDIA

Name : PANKAJ KAPASI  
Phone : 09845010997  
Email : fasteners@kapasiinc.com  
Website : [www.kapasiinc.com](http://www.kapasiinc.com)  
Contact Person Name : PANKAJ KAPASI

### Profile

Major Products & Services: Self Clinch Fasteners, Blind Rivets, Blind rivet nuts, Panel Fasteners, Plastic/Nylon Fasteners, Special fasteners for thin sheet assembly and fabrication, Riveting and clinching tools, Hinges, Latches, Handles, Captive screws, Quarter Turn Hardware, Display/Monitor mounts, Inject-Eject Mechanism and other innovative products Authorized distributors for: Captive fasteners Corp. USA, SOUTHCO-USA, Tubtara-Belgium, LCM -Italy, Spurway, Karat-Taiwan, Auto-sert USA, Bralo - Spain, SOUTHCO etc. Area of application: Defence, Aerospace, Military, Telecom, HVAC & R, EMS, Automobile, elevators, Medical equipments, Food Processing, consumer electronics, public sector and private sector units.

Hall No. : Hall & CHALET  
Stall No. : E1.1, CHALET.12

### KARNATAKA UDYOG MITRA (GOVERNMENT OF KARNATAKA)

Name : Gangadharaiah .  
Phone : 9448363634  
Email : md@kumbangalore.com  
Website : <https://ebiz.karnataka.gov.in/ebiz>  
Contact Person Name : M V Manjula

### Profile

**ABOUT KARNATAKA UDYOG MITRA** Karnataka Udyog Mitra (KUM) is a Government of Karnataka organization constituted under the aegis of the Commerce & Industries Department. Karnataka Udyog Mitra is an initiative by the State to promote and facilitate investments, and hand hold investors. As the designated nodal agency, the organization's role is to facilitate investments and execute initiatives to ensure seamless implementation of the project. **OBJECTIVES** Karnataka Udyog Mitra is a nodal agency at both the state and district level. The organization provides hand holding to all investors and acts as a problem solving body for all small, medium, and large industries to provide necessary assistance. KUM also disseminates information on investment opportunities in the state through media outreach. **KARNATAKA UDYOG MITRA** Provide secretarial support to the High Level Clearance Committee, State Level Single Window Clearance Committee and the District Level Single Window Clearance Committee. Carryout investment promotional activities. Render assistance in policy formulation for industrial progress. Guide and assist businesses to set up industries in the State. **IMPORTANCE AND KEY INITIATIVES** Karnataka Udyog Mitra acts as a single point of contact for all investors looking to set up businesses in Karnataka. The organization understands the needs of industries and chalks out a clear road map with precise and user-friendly directions. Karnataka Udyog Mitra also acts as the Secretariat for grant of approvals and sanction of infrastructure facilities for approved projects. **KEY INITIATIVES** Single Window Clearance System to facilitate ease of doing business in the state. Central Inspection System for a unified departmental Affidavit Based Clearance System.

Hall No. : Hall F  
Stall No. : F1.1

### KINGSLY INSTRUMENTATION AND COMMUNICATION PRIVATE LIMITED

Name : SHEIK AHMED H M  
Phone : 9845035675  
Email : sheik.ahmed@kingslyonline.in  
Website : KINGSLY INSTRUMENTATION AND COMMUNICATION PVT LTD

### Profile

Established in 1993, Kingsly Instrumentation & Communication Pvt Ltd (KICPL) offers hi-rel components, data conversion, prognostics and test & measurement solutions. We represent reputed Principals from across the globe.

Hall No. : Hall G  
Stall No. : G2.3,G2.4

### KUSUMGAR CORPORATES PRIVATE LIMITED

Name : Sarnath Khandelwal  
Phone : 02261125139  
Email : sarnath.khandelwal@kusumgar.com  
Website : www.kusumgar.com  
Contact Person Name : Sarnath Khandelwal

#### Profile

Mr. Y.K. Kusumgar established, M/s. Kusumgar Corporates Pvt. Ltd., way back in 1970. Beginning with synthetic filter fabrics, Kusumgar Corporates Pvt. Ltd. expanded its activities to wide range of technical textiles at a time when technical textiles were in infant stage in India. Since it's inception, the business philosophy of M/s. Kusumgar Corporates Pvt. Ltd. has been to promote product and market development of Technical Textiles through innovative and matured technologies with the help of expert and experienced team of technocrats. The company has a diversified product range weighing 30 gsm to 1000 gsm produced on wide range of weaving machines viz. conventional, projectile, rapier, and water jet machines. Production facility includes coating with polymeric materials such as Vinyl, Acrylic and Urethanes and also impregnation for fire retardancy, water repellency, oil repellency, microbial resistance, etc. with in-house testing facility.

Hall No. : Hall A  
Stall No. : A6.2a, 6.2b

### KWI

Phone : +1 447785591269  
Email : geaviation.media@ge.com  
Website : www.geaviation.com

#### Profile

KWI consists of 2 company profiles GE Aviation & DSCA. GE Aviation operating unit of GE (NYSE:GE), is a world leading provider of jet and turboprop engines, components and integrated systems for commercial, military, business and general aviation aircraft. GE Aviation has a global service network to support these offerings.

Hall No. : Hall G  
Stall No. : G4.6

### LAKSHMI VACUUM TECHNOLOGIES PRIVATE LIMITED

Name : Manjunath BC  
Phone : 7022038671  
Email : marketing@lakshmivacuum.com  
Website : www.lakshmivacuum.com  
Contact Person Name : Manjunath BC

#### Profile

Vacuum Furnace Manufacture , Vacuum Heat Treatment

Hall No. : Hall A  
Stall No. : A3.6,A3.7

### LAVERSAB INDIA

Name : Ravi Shankar Raghunathan  
Phone : 9971863379  
Email : shankar@laversabindia.in  
Website : LAVERSAB INDIA  
Contact Person Name : Ravi Shankar Raghunathan

#### Profile

LAVERSAB INDIA

Hall No. : Hall G  
Stall No. : G4.3

### LEACH INTERNATIONAL EUROPE SAS

Name : Sylvie Amann  
Email : sylvie.amann@leachint.com  
Website : http://www.leachint.com  
Contact Person Name : Sylvie Amann

#### Profile

LEACH International Europe designs and manufactures electromechanical hermetically sealed relays for harsh environment (0,5 to 50Amp), contactors (30 to 1000Amp), relays for space applications, relay sockets, current and voltage sensors, smart switching devices (RCCB, GFI), limit switches, switch lights and indicators, and also equipment as AC and DC Power Distribution Units, solid state power controllers boards, electronic equipment per customer specification, aircraft electrical systems integration.

Hall No. : Hall F  
Stall No. : F2.1

### LEGEND TECHNOLOGIES INDIA PRIVATE LIMITED

Name : Enti Ranga Reddy  
Phone : 9399999878  
Email : marketing@legendtechnologies.co.in  
Website : https://legendtechnologies.co.in/  
Contact Person Name : Surya Teja Mogalapu

#### Profile

AS9100D certified company, which offer end-to-end and cost-effective solutions for the design and manufacturing of aerospace assembly jigs, aero structures, high precision slip rings and development of Ultra-light helicopters.

Hall No. : Hall F  
Stall No. : F6.7

### LEONARDO

Name : Kimberly Silenzi  
Email : [accounting@ediconsult.com](mailto:accounting@ediconsult.com)  
Website : [www.leonardo.com](http://www.leonardo.com)  
Contact Person Name : Kimberly Silenzi

#### Profile

Leonardo, formerly Leonardo-Finmeccanica and originally Finmeccanica, is an Italian multinational company specialising in aerospace, defence and security. Headquartered in Rome, Italy, the company has 180 sites worldwide. It is the eighth largest defence contractor in the world based on 2018 revenues.

Hall No. : Hall A  
Stall No. : A4.7,A4.8,A4.9

### LHG SPECIALITY STEEL INTERNATIONAL PRIVATE LIMITED

Name : Banadesh Mathad  
Phone : 9686111717  
Email : [banadesh.mathad@libertysteelgroup.com](mailto:banadesh.mathad@libertysteelgroup.com)  
Website : [www.libertysteelgroup.com](http://www.libertysteelgroup.com)  
Contact Person Name : Mr. Banadesh Mathad

#### Profile

LHG Speciality Steel International Pvt Ltd is set up by Speciality Steel UK Limited as 100% subsidiary to Establish A Warehouse/Distribution Center of Aerospace and Defense Quality Raw Material such as Super Speciality Steel, Nickel Alloys, Metal Powders for 3D printing to name a few. Currently, the company is supplying the Aerospace quality raw material to Indian Aerospace and Defense components manufacturers and supplying to both Govt and Private Indian Aerospace Companies in India ( Forgings, Machined Component manufacturers and exporters).

Hall No. : Hall H  
Stall No. : H4.6

### LPSIS PRIVATE LIMITED

Name : Nidhi Garg  
Phone : 8295550159  
Email : [nidhi.garg@lpsboi.com](mailto:nidhi.garg@lpsboi.com)  
Website : [www.lpsis.co.in](http://www.lpsis.co.in)  
Contact Person Name : Nidhi Garg

#### Profile

LPSIS PVT. LTD. in India is highly regarded by various sunrise industries for its engineering known and technologically advanced product offerings. The Company is collocated along with UPS Lakshmi, a state of art manufacturing campus, highly trusted by

world's top brands for its engineered products, Campus has ISO 9001, ISO 14001, IATF 16949, ISO 9100D, ISO 45001, ISO 17025 NADCAP- Heat Treatment and NDT, CE Marking amongst top accreditations of its products in sectors in Défense & Aerospace, Auto/EV, Medical, Renewable Energy, Heavy Machineries. We want to be the preferred contact for any manufacturer needing assembly technology solutions and distinguished itself from its competitors by being designated as a specialist in this field worldwide from years of cooperation with our customers we know what achieves proven and sustainable impact.

Hall No. : Hall B  
Stall No. : B4.3

### MAINI MATERIALS MOVEMENT PRIVATE LIMITED

Name : Rohan Reddy  
Phone : 9810649969  
Email : [rohan.r@mainimail.com](mailto:rohan.r@mainimail.com)  
Website : [www.mainigroup.com](http://www.mainigroup.com)  
Contact Person Name : Sharan Mehta

#### Profile

Maini Group is one of India's premier design and manufacturing entities. Its domestic and global dominance in high-precision engineering components, materials handling, warehousing and logistics solutions, aerospace and electric vehicles are due to its creativity and initiative that, among other things, led it to be the first in India to design and manufacture eco-friendly electric vehicles. While its manufacturing base is in India, the warehousing and marketing networks extend across more than 25 countries with over 75% of the turnover being exported to over 200 loyal international customers. Maini Group is characterized by its commitment to complete customer care, sustained research, design, development, and achieving global quality benchmarks and certifications.

Hall No. : Hall B  
Stall No. : B3.1

### MBDA

Name : Catherine  
Phone : +33 33171541000  
Email : [catherine.collignon@mba-systems.com](mailto:catherine.collignon@mba-systems.com)  
Website : [www.mbda-systems.com](http://www.mbda-systems.com)  
Contact Person Name : Catherine

#### Profile

MBDA is a world leading missile systems company with a comprehensive product range designed to meet the land, naval and airborne guided weapon system requirements of each of the armed forces. MBDA is jointly owned by Airbus (37.5%), BAE Systems (37.5%), and Leonardo (25%).



Hall No. : Hall B  
Stall No. : B1.3

### MERLINHAWK AEROSPACE PRIVATE LIMITED

Name : Ashok Sunder  
Phone : 9845687006  
Email : ashok@merlinhawk.com  
Website : www.merlinhawk.aerospace.com  
Contact Person Name : Mr. Ashok Sunder

#### Profile

Merlinhawk, an AS9100D (ISO9001:2015) certified company, has built its reputation over three decades as a trusted partner for OEMs, user agencies and operators in the aviation and defence sectors for customised solutions. We have over three decades of experience and are backed by all requisite accreditations as a Military and Civil Design Organisation. We offer top quality electronic and electromechanical products and value added services guaranteed for reliable performance, especially in rugged and highly challenging environments. These include airborne and ground support products, test and measurement equipment, microwave products and solutions as well as cable harness assemblies, integration, installation including product lifetime support.

Hall No. : Hall B  
Stall No. : B5.16

### METAL EXTRUSIONS

Name : Prem Kumar  
Phone : 09686198234  
Email : unit2@themetalextrusions.com  
Website : metal extrusions  
Contact Person Name : Prem Kumar

#### Profile

Aluminium Raw Material Supplier

Hall No. : Hall G  
Stall No. : G3.7

### MIKROFLO FILTERS PRIVATE LIMITED

Name : Krishnakanth VRG Dittakavi  
Phone : 8008899901  
Email : krishnakanth@mikroflo.com  
Website : www.mikroflo.com  
Contact Person Name : Krishnakanth VRG Dittakavi

#### Profile

Mikroflo Filters Private Limited is the pioneers in filtration technology for liquid, air and gas for I.C. Engines, Military applications and industrial applications. We have a proven track

record right from 1975 both for quality and customer care. We have in-house test facilities equipped with latest Test rigs (equipment) of international standard. Our R&D was approved by the Ministry of Science and Technology of Government of India. Our clients include DRDO, GTRE, ADA, HAL, Indian Navy, L&T SBC, ONGC, MRPL, HPCL, BPCL, NTPC, BHEL and many Petrochemical & Power Generation Units and Fertilizer Units.

Hall No. : Hall E  
Stall No. : E.5.3

### MISHRA DHATU NIGAM LIMITED (MIDHANI)

Name : Nagesh Yenpreddiwar  
Phone : 9100773105  
Email : nagesh.y@midhani-india.in  
Website : https://midhani-india.in  
Contact Person Name : Nagesh Yenpreddiwar

#### Profile

MISHRA DHATU NIGAM LTD (MIDHANI), A Govt. of India Enterprises, was set up in 1973 at Hyderabad. MIDHANI is a Mini Ratna, ISO 9001:2015 and AS 9100:2016, ANAB accredited and QC-NABL accredited company with modern metallurgical facilities and high degree of technical competence for manufacturing a wide range of Super Alloys, Titanium alloys, Special Steels and other special metals meeting international standards and specifications for application in Aerospace, Defence, Energy, Chemical and other hi-tech industries. MIDHANI is the major Aeronautical alloy grade manufacturer in INDIA. MIDHANI has developed more than 350 grades out of which 46 No. of grades used in Aero Industry were type approved by Airworthiness agencies such as CEMILAC and DGAQA.

Hall No. : Hall H  
Stall No. : H5.3

### MISOCHAIN TECHNOLOGIES PRIVATE LIMITED

Name : Murali Krishnan P  
Phone : 75101 72061  
Email : murali@misochain.in  
Website : www.misochain.in  
Contact Person Name : Murali Krishnan P

#### Profile

Misochain accelerates business growth by democratizing digital technology in Manufacturing. At Misochain, we are continuously innovating to make this journey faster, easier and more impactful for our customers and partners. We envision the transformation of Manufacturing with Industry 4.0 technologies by creating an innovative platform with a fully digital value chain. Our Three main offerings are 1. Product as a Service (PaaS) 2. Manufacturing as a Service (MaaS) 3. Software as a Service (SaaS).

Hall No. : Hall G  
Stall No. : G3.5

### MISSION AEROSPACE FOUNDATION OF INDIA

Name : sathyavathi v  
Email : arunakar.mishra@aerofi.in  
Contact Person Name : Arunakar Mishra

#### Profile

Aerospace Design, Manufacturing and Aviation Services

Hall No. : Hall A  
Stall No. : A7.3a

### MKU LIMITED

Name : Radhika Prakash  
Phone : 7259132850  
Email : Radhika.prakash@mku.com  
Website : www.mku.com  
Contact Person Name : Radhika Prakash

#### Profile

MKU Ltd., a global defence and homeland security company, headquartered in Uttar Pradesh, India, on a mission to empower heroes. We offer smart optronic and ballistic protection solutions indigenously developed in India, for soldiers and platforms for military, paramilitary, homeland security, police and special forces.

With a footprint in over 100 countries, we continue our endeavour to empower over 3 million soldiers and 3000+ platforms across 230 forces. Our products are tested and certified by leading labs and agencies in the world including National Institute of Justice (NIJ), USA. Our facilities are AS-9100-2009 and ISO 9001-2008 certified in addition to the much coveted & stringent BA 9000 certification. We follow NATO AQAP quality standards and are also registered with International Aerospace Quality Group (IAQG). Our R&D House is recognized by the Govt. of India and aggressively invest 10% of our annual turnover into R&D activities. Additionally, we hold over 10 patents in India & abroad.

Hall No. : Hall F  
Stall No. : F6.8

### MRF LIMITED

Name : MADHU G  
Phone : +91 9840072496  
Email : madhu.g@mrffmail.com  
Website : www.mrftyres.com  
Contact Person Name : G MADHU

#### Profile

MRF Limited, which began as a toy balloon manufacturer in 1946, is now a 2.35 billion-dollar company with tyre products for every market segment with 10 manufacturing facilities in India. We are the largest manufacturers of tyres for automobiles and aircraft in the various fleets of the Indian armed forces. We are the first Indian company to indigenize the tyres for various military aircraft in India. MRF enjoys the highest brand preference in each of the respective segments. MRF exports tyres to over 90 countries and is the largest OEM supplier. MRF has its own aircraft tyre testing facility in the R and D Center in Chennai, India.

Hall No. : Hall H  
Stall No. : H5.5

### MULTIPLE SPECIAL STEEL PRIVATE LIMITED

Name : Aditya Bharadwaj  
Phone : 8123004959  
Email : aditya@msspl.co  
Website : www.msspl.co  
Contact Person Name : Kumaran

#### Profile

We are an EN 9120:2018 certified trading firm dealing in ferrous and non-ferrous metals for applications in aerospace and defence. with over six decades of experience catering to a wide spectrum of industries in the tooling fraternity like aerospace, defence, automotive, medical, white goods etc. We are also certified to ISO 9001:2015 with our value added line consisting of machining, grinding, deep hole drilling and tapping all under one roof. Multiple special steel strongly believes in the mantra by our founder and m M.D, Shri. N.R.G.Krishnan "Economy through quality, together we prosper" to serve our customers "On time, everytime".

Hall No. : Hall E  
Stall No. : E.3.4

### MUNITIONS INDIA LIMITED

Name : RAJAT SAXENA  
Phone : 9890091886  
Email : rajatsaxena@munitionsindia.in  
Website : munitionsindia.co.in  
Contact Person Name : RAJAT SAXENA

#### Profile

Munitions India Limited [MIL] is Defence Public Sector Enterprise [CPSE] under the Ministry of Defence, Government of India. MIL, India's biggest manufacturer and market leader, is engaged in Production, Testing, Research & Development and Marketing of comprehensive range of ammunition & explosives for Army, Navy, Air Force & Para-Military Forces. With Corporate Office at Pune (India), MIL in its 12 state-of-the-art manufacturing units located



across the country employs skilled workforce of around 23,000. These factories have proven integrated base for production of Small, Medium & High Calibre Ammunition, Mortars, Rockets, Hand Grenades etc. with in-house manufacturing of Initiatory Compositions, Propellants and High Explosives for over 150 years. Our primary objective is to provide competitive edge to the Armed Forces by equipping them with modern and quality battlefield ammunition. Our foreign customers include countries located in North America, South America, Europe, Africa and Asia.

Hall No. : Hall F  
Stall No. : F1.2

### NASMYTH ASIA (INDIA) PRIVATE LIMITED

Name : Ashwini V  
Phone : 9036011442  
Email : ashwini@nasmythasia.com  
Website : www.nasmythgroup.com  
Contact Person Name : Harish D

#### Profile

Nasmyth Group established Nasmyth India in 2013 to enhance the Group's ability to provide cost-effective precision engineering solutions for the aerospace, energy, industrial gas turbine and related industries on a worldwide basis. Based in Bangalore, Nasmyth India, through its Indian partner companies, manufacture precision parts to the highest quality standards using modern CNC machining facilities. In addition, the company has the ability to manufacture complex, quality assured assemblies and deliver professional CAD/CAM design and reverse engineering services.

Hall No. : Hall G  
Stall No. : G4.1

### NEWSEYE MEDIA PRIVATE LIMITED

Name : AMIT GOYAL  
Email : amit@newslines.in  
Website : www.geopolitics.in  
Contact Person Name : Amit Goyal

#### Profile

Geopolitics, a monthly publication, is an authoritative, independent and professional source of information for India's top decision-makers on the defence and security scenario. The magazine provides a unique perspective to discourse on issues of the region, particularly with respect to security and defence.

Hall No. : Hall C  
Stall No. : C5.2

### NEWSPACE RESEARCH AND TECHNOLOGIES PRIVATE LIMITED

Name : Siddhesh Naik  
Phone : 8369659025  
Email : Siddhesh.naik@newspace.co.in  
Website : www.newspace.co.in  
Contact Person Name : Siddhesh Naik

#### Profile

Founded in 2017, NewSpace Research and Technologies (NRT) is a Bangalore based company that focuses on Next-Generation Missions & Technologies (NG-MT) with a focus on Unmanned Aerial Systems. The company is led by Mr Sameer Joshi (Co-Founder and CEO) and Mr Julius Amrit (Co-Founder and COO) who have more than two decades of experience. The company has been a pioneer in India in UAS (UAV) swarming (Multi rotor unmanned systems - MUAS) and has secured multiple supply orders from the defence forces. NRT's team of 200+ engineers have developed advanced capabilities in 'Cyber Physical' systems, with the key domains being: •Autonomous Software: AI, ML, CV based algorithms for autonomous flights and imbibing concepts of collective robotics and advanced Human/ Machine interface •Manned Unmanned Teaming (MUM-T) •Aircraft Design - Multi-Disciplinary Optimization based design of aircraft platforms for best-in-class platform performance for a said use case •Manufacturing – 35,000 sqft of manufacturing facility • Flight Operations – Skilled Flight Ops team that has flown and operated different classes of UAV aircraft (Multi – Copters, Fixed Wing) over varied terrains NRT, since its inception has been the pioneer in India in autonomous 'UAV Swarming' and has been evangelizing this concept across the defence establishment (MoD, Army, IAF, Navy). The genesis for UAV Swarming at NRT was IAF's Meher Baba Prize for UAV swarming wherein IAF wanted Indian companies/ start-ups to demonstrate swarm operations for 'Humanitarian Aid and Disaster Relief (HADR)'. NRT won the competition and dominated all the participants with its swarm tech. Meanwhile the Indian Army very quickly identified the decisive edge that 'UAV Swarms' bring to their operations and went ahead with capability developmental orders (first order in Nov 2020) to NRT through its Secunderabad based division, Simulator Development Division (SDD) for UAV Swarms. NRT has recently made a record of successfully flying a UAV swarm of Nimbus at 25,000 ft above mean sea level. No other organization has been able to achieve this. NRT's flagship programs like Fixed Wing and HAPS are recognized by the Indian MoD and US Defence committee. NRT has also raised a Series – A funding of INR 160 Cr in Q1 2022. NRT has entered into Research and Development partnerships with the end user (Indian Army, IAF, Indian Navy) for developing Next Generation Mission Technologies (NG-MT) capabilities through indigenous Research and Development. NRT also has India's first collaborative research and development agreement (CRADA) with the US - Air Force Research Labs (AFRL) since 2019.

Hall No. : Hall F  
Stall No. : F4.4

### NEXT DEFENCE PRIVATE LIMITED

Name : George Jacob  
Phone : 8105077733  
Email : george@nextdefence.com  
Website : www.nextdefence.com  
Contact Person Name : George Jacob

#### Profile

Next Defence is harnessing the power of technology and innovation, to create unique products in defence domain in the spirit of 'Atma Nirbharta'. Next Defence's product range comprises electric vehicle platforms, energy storage solutions, drones, UAVs, simulators, AI and robotics, electro-optical surveillance, image and data annotation services, non-lethal ammunition and more. It is also developing new products by working closely with the academia. Additionally, Next Defence offers professional and technical consultancy, engineering services, annual maintenance contracts and after-sale services, joint venture partnership, sales and marketing representation, and license holder for domestic and international manufacturers and suppliers of defence equipment. The Company's vision is to provide end-to-end solutions that empower the defence sector to the fullest.

Hall No. : Hall A  
Stall No. : A2.10

### NICOMATIC INDIA ELECTRONICS PRIVATE LIMITED

Name : Satprakash Tiwary  
Phone : 080 4213 1574  
Email : m.sharieff@nicomatic.in  
Website : www.nicomatic.com  
Contact Person Name : Maheeb Sharieff

#### Profile

Nicomatic India Electronics Pvt Ltd based in Bangalore, was formed in 2011. Initially Nicomatic was exclusively involved in trading of mechanical/ electrical / electronic connectors, cables, wiring harness and related hardware activities for Defence, Aerospace and various other related industries. We have setup Manufacturing unit at Hitech Defence and Aerospace Park and started manufacturing above product from June 2022 and Nicomatic product are International Standards and are widely used by companies such as BEL, DRDO, BDL, RCI and other defence companies.

Hall No. : Hall F  
Stall No. : F3.9

### NIVOX TECHNOLOGIES

Name : Hemanth Kumar  
Phone : 9845504242  
Email : hemanth@nivoxtech.com  
Website : www.nivoxtech.com  
Contact Person Name : Hemanth

#### Profile

Iveonet™ has been part of Nivox Technologies™, A leading supplier of Industrial Ethernet products, Rugged Fiber Optic Products and solutions for various industries worldwide. Coming together as one, Iveonet™ and Nivox Technologies™ offer an exclusive capability to provide customers with an unmatched combination of products for Railways, Enterprise, Process Automation, Datacom, Premise wiring, Oil & Gas, Utility and security markets with more complete and innovative solutions to meet their needs today and in the future.

Hall No. : Hall B  
Stall No. : B5.14

### NOBLE AEROSPACE PRIVATE LIMITED

Name : Adarsh Shishoo  
Phone : 9971822711  
Email : business@noblefix.com  
Website : www.noblefix.com  
Contact Person Name : Adarsh Shishoo / Ranjeet Singh Bisen

#### Profile

We are an AS9120:2016 Certified Company and an approved supplier to the leading companies of North American & European Aerospace Committees including Indian Aerospace & Defence companies. We are authorized suppliers of Aerospace Grade HeliCoil Inserts, Threaded Insert Systems, Aerospace Fasteners, Washers, Rivets, Nuts, & related Installation Tools and thread gauges. HeliCoil inserts & other Thread Inserts are released conforming to standards of AIA, IAI, EADS, SBAC, SAE, MS21209, NASM21209, NAS1130, MS51830-MS51832, NAS1394 - NAS1395, Boeing BACi12AE, Airbus & Rolls Royce Parts - AGS3600/3700/4677, AS6733, AS6734, AS8455, AS8456, AS3094, AS3095, AS3096, AS3097, Collins Aerospace, GOODRICH, UTAS, Honeywell, RAFAEL Parts, LN9039 LN9499, MA3279-3281, MA3329 -3331, MS122076 to MS124831, products meeting the requirements of Saffran Group, Turbomeca, GENERAL ELECTRICS- GE N926. GE-Aerospace, Thread Repair Kits per Aviation Standard of FAA, CAA, JAA. Thread Cutting Taps as per DIN, ISO, ASTM, NASM33537, UNJ, UNJF, MJ profiles per FED-STD-H28 & SAE8879 standards

Hall No. : Hall F  
Stall No. : F3.13

### NUCON AEROSPACE PRIVATE LIMITED

Name : Lakshmi Bhavani  
Phone : 8790005039  
Email : sales@nuconaerospace.com  
Website : www.nuconaerospace.com  
Contact Person Name : Lakshmi Bhavani

#### Profile

This is to inform you that Nucon Aerospace Private Limited is a Production Center for complete Integrated Missile Sections, Control Actuation Systems, Embedded Control Systems, Avionics and Cable Assemblies, all located in a well-established industrial area of Hyderabad.

Hall No. : Hall F  
Stall No. : F3.11

### NUCON ALKAN AEROSPACE PRIVATE LIMITED

Name : Lakshmi Bhavani  
Phone : 8790005039  
Email : sales@nuconalkan.com  
Website : www.nuconaerospace.com  
Contact Person Name : Lakshmi Bhavani

#### Profile

Nucon Aerospace has formed a Joint venture with Alkan a leader in weapon carriage & release system. The Joint venture is called Nucon Alkan Aerospace Pvt Ltd and it is registered with MCA, Govt of India, Nucon hold 51% stake & Alkan 49% stake. The main objective of the Joint Venture is to MAKE IN INDIA, and we have started manufacturing parts for Alkan ERU 1925 for exports projects.

Hall No. : Hall F  
Stall No. : F3.12

### NUCON PNEUMATICS PRIVATE LIMITED

Name : Lakshmi Bhavani  
Phone : 08790005039  
Email : lakshmibhavani@nuconaerospace.com  
Website : www.nuconaerospace.com  
Contact Person Name : Lakshmi Bhavani

#### Profile

As a company that has significant expertise in the field of Control systems, High pressure Air systems, High pressure valves, manipulators, electro Pneumatic valves, electro hydraulic valves Integrated Missile sections, control actuation systems, embedded

control Systems, avionics, and cable assemblies, all located in a well-established industrial area of Hyderabad. Further we are the developers & manufacturers of below mentioned subsystems for Indian Navy & Indian Defence 1.High Pressure systems for Indian Navy 2.High/Low Pressure inline filter for S3, S4 & S5 for Indian Navy 3.Block drying unit for Indian Navy 4.Block slide valve assembly for Indian Navy 5.Air Typhoon for Indian Navy 6.F S R - Under Development for Indian Navy 7.Akash SEC-III 8.Electro Mechanical actuators for QRSAM, MRSAM & Akash NG Projects 9.Tail & Wing actuators along with controllers for LRGB 10.Rotary electro mechanical actuator (Rema 20) for Pinaka 11.Rotary electro mechanical actuator (Rema 20) for SAAW 12.Rotary electro mechanical actuator (Rema 40) for ASTRA MK - II & VL SRSAM 13.Fuel Dump Valve for ALH 14.Fuel Shutoff valve for ALH- Under Development 15.Pneumatic Ejection System for BrahMos AV 16.PS1 SITVC Valves for ISRO 17.Brake Cylinders

Hall No. : Hall B  
Stall No. : B5.24

### ORIENTAL WEAVING & PROCESSING MILLS PRIVATE LIMITED

Name : Abhedya Yeole  
Phone : 9820108215  
Email : abhedya@orientalmills.in  
Website : www.orientalairsys.in  
Contact Person Name : Abhedya Yeole

#### Profile

Oriental Airborne Systems has expert capabilities in the design, development & production of airborne delivery & recovery system solutions & engineered textile fabrication. We manufacture Parachutes, Cargo Delivery, Space Recovery, Rigging, Technical Textiles, Drone Parachute Systems & Aerostats

Hall No. : Hall F  
Stall No. : F3.4

### PARAS WIRES PRIVATE LIMITED

Name : Arunsimha GS  
Phone : 9880366001  
Email : marketing@paraswires.net  
Website : www.paraswires.net  
Contact Person Name : Arunsimha GS

#### Profile

PWPL Profile An ISO, AS, DGQA registered and with LCSO approval company. Manufacturer and supplier for over 3.5 decades of wire, cable and assemblies for all 3 services-Defence, Aerospace and Marine -Specialised in import substitution, indigenisation and new innovations. Speciality cables including multicore cables developing and manufacturing to exacting requirements of Aerospace and defence.

Hall No. : Hall B  
Stall No. : B5.17c

### PAWAN HANS LIMITED

Name : Sanjay Kumar  
Phone : 8588988886  
Email : sanjay.kumar@pawanhans.co.in  
Website : www.pawanhans.co.in  
Contact Person Name : V.C Tiwari

#### Profile

Pawan Hans Ltd. (PHL), a Govt. of India Enterprise under Ministry of Civil Aviation, is a pioneer in helicopter operations. Company is providing helicopter services in the areas of Offshore, Passenger transportation, VIP Flying, Medical Evacuation, Inter-Island connectivity, Seaplane, RCS UDAN, Tourism, Pilgrimage and providing its services in the States/ UTs of Ladakh, J&K, Uttarakhand, Sikkim, Maharashtra, A&N and Lakshadweep. Company is providing technical consultancy/ DPR to various State Govt. and UTs for developing facilities of Heliports/ Helipads for helicopter operations, Heli Tourism, Night Landing facilities at Helipads, Feasibility study for operating Amphibious Seaplanes.

Hall No. : Hall B  
Stall No. : B5.10,B5.11

### PBS INDIA PRIVATE LIMITED

Name : Ravi Hazarika  
Phone : 8197206600  
Email : hazarika@pbsindia.com  
Website : https://www.pbsindia.com/  
Contact Person Name : RAVI HAZARIKA

#### Profile

PBS INDIA PRIVATE LIMITED product and solutions profile consist of aircraft engines, auxiliary power units (APU), environmental control systems (ECS), specific custom-made aircraft solutions, cryogenics, and investment casting products.

Hall No. : Hall G  
Stall No. : G4.5

### PEI-GENESIS

Name : Sriram Nandakumar  
Phone : 98101 25051  
Email : sriram.nandakumar@peigenesis.com  
Website : www.peigenesis.com  
Contact Person Name : Sriram Nandakumar

#### Profile

PEI-Genesis is a global leader in the design and assembly of custom-engineered connectors and cable solutions for harsh environments. PEI partners with customers to design engineered solutions that meet specific application requirements and then deliver with speed, service, and consistent quality that is unmatched in the industry. Proprietary automation in mirrored factories around the world allows PEI to assemble, from one of the largest inventories of electronic components, according to customers' specific requirements. PEI develops custom interconnect solutions that support the harsh environments of the aviation, energy, military, industrial, rail, and medical sectors worldwide. With fast shipping and excellent, responsive service, PEI-Genesis provides access to the brands that design engineers trust. PEI's line card includes the top global brands in the connector industry, including Amphenol, ITT Cannon, Cinch Connectivity Solutions, Souriau and Sunbank by Eaton, and Positronic.

Hall No. : Hall C  
Stall No. : C2.1,C2.2,C2.3

### PINAKA AEROSPACE SOLUTIONS PRIVATE LIMITED

Name : Radhika Pasumarthi  
Phone : 9845023332  
Email : radhika@pinaka.co.in  
Website : www.pinaka.co.in  
Contact Person Name : Radhika Pasumarthi

#### Profile

Pinaka Aerospace Solutions Pvt. Ltd. has been in the service nation catering a wide range of system integration solutions on turnkey basis since past more than a decade with a key focus in Test & Measurement, Embedded Hardware, Software, IV&V, Simulation, Indigenization and Obsolescence Management. Pinaka is head quartered in the Silicon City of India, Bangalore. Our key focus has been Aerospace & Defence being an ISO 9001:2015, AS9100:2016 and CEMILAC certified company providing both ground as well as on-board solutions & products. We are also certified by DGAQA. Way forward, Pinaka is also evolving its presence into global supply chain of Aerospace & Defence by joining hands with pioneered companies in other nations of USA and Europe regions. We are recognized as an offset partner of MoD in Israel. Our endeavor is to consistently deliver innovative, high quality, reliable and cost-effective solutions, products and services on time. The presence of Pinaka in Indian Aerospace & Defence has been across many key programs including Light Combat Aircraft (LCA-Tejas), Jaguar, AVRO, Sukhoi, HAWK and others. We have been increasingly executing many projects year on year with DRDO, Indian Air Force, Army, Defence Public Sector units including Hindustan Aeronautics Limited (HAL) and Bharat Electronics Limited (BEL) as well as several other Government organizations in India. We have also indigenized several key products including No Volts Cum Pulse Tester, I-Level & O-Level Testers, Under Carriage Display Unit (UCDU), Fuel Flow Indicator, Anti-Collision Light, G-meter etc. apart from development of Automatic Test Equipment (ATEs), Hardware-In-Loop Simulators (HILS), Data Acquisition & Control Systems and Flight Simulators to Indian Defence



Hall No. : Hall G  
Stall No. : G3.2

### PROCESSWARE SYSTEMS PRIVATE LIMITED

Name : Guru Murthy  
Phone : 9844099110  
Email : guru@ptpl.com  
Website : www.ptpl.com  
Contact Person Name : Mohanram P V

#### Profile

Processware is an AS 9100 and CMMi/Dev3 certified organization based in Bangalore. Processware has deep expertise in Embedded System and Airborne Software. Processware has worked on more than 40 projects in aerospace since 1995. Processware has expertise in DO 178C and DO 254 standards. Processware was involved in one of the largest embedded system built in the country for Tejas. The company has worked on Radars, Missiles, UAVs, Aircraft subsystems, Engine Control units etc.,

Hall No. : Hall A  
Stall No. : A2.5

### PRODIGY TECHNOVATIONS PRIVATE LIMITED

Name : NITIN BORKAR  
Phone : 8970771421  
Email : nitin.borkar@prodigytechno.com  
Website : https://prodigytechno.com/  
Contact Person Name : Nitin

#### Profile

DO-254 Solution Provider, Different digital Protocol solutions Provider

Hall No. : Hall C  
Stall No. : C4.2

### PTC INDUSTRIES LIMITED

Name : Vaibhav Srivastava  
Phone : 9305222336  
Email : vaibhav.srivastava@ptcil.com  
Website : www.ptcil.com  
Contact Person Name : Vaibhav Srivastava

#### Profile

PTC Industries Limited is one of the world's leading suppliers of high precision components for critical and niche application across a wide range of sectors including Aerospace, Defense & Space. PTC's wholly owned subsidiary, Aerolloy Technologies is presently engaged in manufacturing of components for Aircraft/ Helicopter Engines, Military drones, UCAVs, Missiles, Submarine, Ultra-Light

Artillery guns, Space launch Vehicles etc. in Titanium & Nickel Based Super Alloys. The company is setting up facilities in Lucknow - UP Defense Industrial Corridor, for Challenging technologies like SX Engine Airfoils, TBC, Small Gas Turbine and Rocket Motor Casings for missile Systems, etc. and also adding up world class manufacturing equipment for Titanium & Nickel super alloys like VAR, EBCHR, VIM & PAM. By 2023 end PTC shall start producing Ti-alloys to the tune of 6500TPA for country's Defense application and target a substantial volume for export to various OEMs of Aircraft manufacturer globally.

Hall No. : Hall A  
Stall No. : A1.4

### PUSHPAK INDUSTRIAL SERVICES

Name : Pushpak Prakash  
Phone : 9845048998  
Email : vision100@pushpak.com  
Website : www.pushpak.com  
Contact Person Name : NARAYANA SWAMY N A

#### Profile

Pushpak is an AS 9100 Rev D & NADCAP Certified Company and has its origin in the year 1992. Pushpak has been designing, manufacturing and delivering high-end precision products and electro chemical processes for the Aerospace, Defence and Automobile sectors. We are partners to ISRO & HAL, for some of the successful ambitious nation building projects. Pushpak, is proud to be part of "Chandrayaana mission" & "Mangalyan Misson (Mars Mission)" of ISRO. Pushpak has bagged FOUR National Award in 2008 & 2009 from ministry of MSME, Government of India, CII-EXIM Bank awards for Business Excellence for the year 2012 and 2013. Pushpak has been selected as one among Top 100 SMES of India. In 2018 Pushpak has received best supplier award from Aerospace Division of HAL

Hall No. : Hall A  
Stall No. : A1.5

### PUSHPAK PRODUCTS INDIA PRIVATE LIMITED

Name : Pushpak Prakash  
Phone : 9845687775  
Email : projects@pushpak.com  
Website : www.pushpak.com  
Contact Person Name : NARAYANA SWAMY N A

#### Profile

Pushpak is an AS 9100 Rev D & NADCAP Certified Company and has its origin in the year 1992. Pushpak has been designing, manufacturing and delivering high-end precision products and electro chemical processes for the Aerospace, Defence and Automobile sectors. We are partners to ISRO & HAL, for some of the successful ambitious nation building projects. Pushpak, is proud to be part of "Chandrayaana mission" & "Mangalyan Misson (Mars Mission)" of ISRO. Pushpak has bagged FOUR National

Award in 2008 & 2009 from ministry of MSME, Government of India, CII-EXIM Bank awards for Business Excellence for the year 2012 and 2013. Pushpak has been selected as one among Top 100 SMES of India. In 2018 Pushpak has received best supplier award from Aerospace Division of HAL

Hall No. : Hall C  
Stall No. : C1.7

### **RADDEF PRIVATE LIMITED**

Name : Chandrashekar K  
Phone : 9986016370  
Email : chandrashekar.k@raddef.in  
Website : www.raddef.co.in  
Contact Person Name : Chandrashekar K

#### **Profile**

Raddef Private Limited a HFCL GROUP company, has been established with a view to put into action "MAKE IN INDIA" policy of the Government of India. Raddef specializes in R&D, manufacture, assembly, testing, qualification, integration & installation of Defence Electronics systems.

Hall No. : Hall C  
Stall No. : C3.12

### **RADEL ADVANCED TECHNOLOGY PRIVATE LIMITED**

Name : GORUR RAJ NARAYAN  
Phone : 9449799325  
Email : hr@radel.in  
Website : www.radel.co.in  
Contact Person Name : Sathyan G

#### **Profile**

Radel is a CEMILAC certified aerospace organization promoted by technocrats with decades of design experience at HAL, Bangalore. We have executed a number of prestigious design and manufacturing projects for HAL as well as the IAF, Indian Army and the Indian Navy, over the last thirteen years. We are registered with various divisions of HAL as well as IAF, Navy and Army as vendors for indigenization in the areas of avionics and instrument systems. Radel is also ISO 9001:2015 certified.

Hall No. : Hall F  
Stall No. : F1.8

### **RADIALL INDIA PRIVATE LIMITED**

Name : Biju George  
Phone : 080 2839 5271  
Email : biju.george@radiall.com  
Website : www.radiall.com  
Contact Person Name : Biju GEORGE

#### **Profile**

Radiall India is in to manufacturing of RF and Fibre optic connectors and cable harness, to meet Mil and aerospace specifications

Hall No. : Hall C  
Stall No. : C5.4,C5.5

### **RAFAEL ADVANCED DEFENSE SYSTEMS LIMITED**

Name : Sofia Vinas  
Phone : +972 73 335 4444  
Email : sofiv@rafael.co.il  
Website : www.rafael.co.il  
Contact Person Name : SOFIA VINAS

#### **Profile**

RAFAEL Advanced Defense Systems Ltd. is synonymous with Dynamic Defense, Daring Innovation, and Technological Ingenuity. For over 70 years, the Company has pioneered advances in defense, cyber and security solutions for air, land, sea, and space. Our innovations are based on extensive operational experience and understanding of evolving combat requirements. They enable the rapid development of effective solutions for complex battlefield challenges. Always ahead we ensure an ongoing advantage for our worldwide client base. We are dedicated to continuously enhancing our customer service, as well as expanding our global industrial cooperation program.

Hall No. : CHALET  
Stall No. : CHALET.29,CHALET.30

### **RAFALE INTERNATIONAL**

Name : Frederic WALLOIS  
Phone : +33 33147 114 000  
Email : frederic.wallois@dassault-aviation.com  
Website : www.dassault-aviation.com  
Contact Person Name : Frederic WALLOIS

#### **Profile**

The long-standing relationship initiated in 1953 when India became Dassault Aviations first export customer with the Toofani and has been continuing without interruption since that date. The latest addition after the Mirage 2000 is the Rafale that was chosen to equip the Indian Air Force in September 2016. Dassault Aviation is committed to fulfilling the offset/Make in India obligation taken in the Rafale contract. It is in that frame that a state-of-the-art factory has been set up in Nagpur (Maharashtra) which will be assembling Falcon 2000 aircraft by 2022 and is aimed at assembling Rafale aircraft if future orders are to come. Dassault Aviation is furthermore developing an indigenous high added-value supply chain under the Make in India policy promoted by Prime Minister Shri Narendra Modi with aim to match the highest international aerospace industry standards. At the end of July 2020, despite the unprecedented COVID world health crisis and after a Dassault Aviation complete training of Indian pilots and technicians, five Rafale operated by Indian Air Force pilots took off from France and were ferried to Ambala Air Force Station to enter service in N°17 Squadron Golden Arrows. Today, while deliveries are on schedule, Dassault Aviation and its Rafale International partners, Safran Aircraft Engines and Thales, are committed to pursue this extraordinary long-standing cooperation by proposing the Rafale to the Indian Navy and the Indian Air Force to continue to support Indian defence and security for the next decades.



Hall No. : Hall A  
Stall No. : A7.3b

### **RANGSONS AEROSPACE PRIVATE LIMITED**

Name : Tulasi VK  
Phone : 9036850360  
Email : marketing@rangsonsaerospace.com  
Website : www.rangsonsaerospace.com  
Contact Person Name : Tulasi

#### **Profile**

Rangsons Aerospace Pvt Ltd., is product development company having expertise in design, manufacturing and testing of equipment and systems for Aviation, Aerospace and Defence sectors. Our area of expertise includes: •Thermal Management Solutions (Heat Exchanger, Cold Plates, Heat Sinks) •F l u i d Management solutions (Pipes, Tubes, Hoses, Ducts) •T a c t i c a l Communications solutions (Satellite Communication terminals, Data Links) •Automated Test Equipment •Electronic Equipment Design and system Integration We are trusted partner in number of mission critical projects. Our Customers includes: •Indian Air Force & Indian Navy •DRDO & ISRO Organisation •Indian DPSU – HAL, BEL, BDL •Global OEMs - Honeywell, IAI, Collins Aerospace, Libeherr, Thales, SIEMENS, General Electrical (GE) • Indian Private Sector – TASL, ASTRA, DATA PATTERN Rangsons Aerospace Pvt Ltd operates for 03 fully owned design and manufacturing facilities in Bangalore and Mysore, Indian. Our 6000 Sqft CEMILAC certified design centre in Bangalore is equipped with latest development tools for design analysis and simulations. Our design and Engineering team has knowledge and expertise in System Integration, LRU, SRU level designing (Microprocessor, DSP, FPGA, 1553B, Arinc429, Device Drivers, GUI, Algorithm Designs) Thermodynamics and Heat Transfer. Our Bangalore Manufacturing facility is spread over 30000 SqFt and equipped with all tools and infrastructure including Vacuum brazing machine, required for manufacturing and testing of plate heat exchangers and other thermal management equipment. Our manufacturing facility at Mysore specialized in Aviation tubes, house and ducts, It has inhouse infrastructure for bending, welding, forming and NDT. All our manufacturing facilities are AS9100D, CEMILAC and NADCAP Certified.

Hall No. : Hall H  
Stall No. : H3.3

### **RATNAMANI METALS AND TUBES LIMITED**

Name : ALKESH SHARMA  
Phone : 9909006327  
Email : alkesh.sharma@ratnamani.com  
Website : http://www.ratnamani.com  
Contact Person Name : MR. ALKESH SHARMA

#### **Profile**

Manufacturer of stainless steel seamless and welded tubes and pipes. nickel alloy seamless tubes, titanium welded tubes, carbon steel welded pipes

Hall No. : Hall A  
Stall No. : A2.7,A2.8

### **RAY-Q INTERCONNECTION TECHNOLOGIES INDIA PRIVATE LIMITED**

Name : Utpal Mittal  
Phone : 9810337901  
Email : utpal@rayq-india.com  
Website : www.ray-q.com  
Contact Person Name : Utpal Mittal

#### **Profile**

Supplier of Mil Grade Components

Hall No. : Hall B  
Stall No. : B5.28

### **REUTECH INDIA PRIVATE LIMITED**

Name : Nitin Sachdeva  
Phone : 9971863379  
Email : nitin.sachdeva@reutech.in  
Website : www.reutech.com  
Contact Person Name : Nitin Sachdeva

#### **Profile**

Capabilities in land, air and sea. Reutech India is a subsidiary of the South African defence group supplying local and export customers with advanced Original Equipment Manufacturer products and services in the land, sea and air defence domains, as well as in the industrial and mining sectors. Reutech companies are leaders in the practical application of advanced proven technologies in product design, support and manufacturing both independently and through partnerships.

Hall No. : CHALET  
Stall No. : CHALET.31

### **ROLLS-ROYCE**

Name : Sarah McCarthy  
Phone : 447917558595  
Email : sarah.mccarthy@rolls-royce.com  
Website : www.rolls-royce.com  
Contact Person Name : Sarah McCarthy

#### **Profile**

Rolls-Royce pioneers advanced, integrated and sustainable power solutions to support our customers' missions, protect our planet, secure our world and explore the universe.

Hall No. : Hall B & CHALET  
Stall No. : B2.3, CHALET.33

### ROSOBORONEXPORT JSC

Name : Igor Pashukov  
Phone : +7-4957396017  
Email : gorbachevtmax@gmail.com  
Website : www.roe.ru  
Contact Person Name : Igor Pashukov

#### Profile

ROSOBORONEXPORT is Russia's sole state agency for export of the full range of defense-related and dual-use products, services and technologies. It is a part of Rostec State Corporation. The geographical scope of Russia's military-technical cooperation encompasses more than 100 countries.

Hall No. : Hall A  
Stall No. : A2.1

### ROTARY CONNECTORS PRIVATE LIMITED

Name : Gangadhar M  
Phone : 9886108327  
Email : girish@rotaryconnectors.com  
Website : http://www.rotaryconnectors.com  
Contact Person Name : Girish Nilange

#### Profile

Rotary Connectors (P) LTD incorporated in the year 2005, is a manufacturer and a market leader of interconnection solutions. We are one of the few Indian companies which manufacture's high performance MIL grade circular connectors that include D38999 S III, MIL-DTL-26482 S I & S II; Backshells; Dust caps & other accessories. The expertise and capabilities acquired over two decades of experience has enabled us to provide solutions to various verticals (Military, Aerospace, Industrial, Information Technology and Data Communication) in the market. We deliver Total Quality Assurance and ensure that all of our products meet quality, reliability, environmental and safety standards for virtually any market around the world. Rotary Connectors (P) LTD hold extensive global accreditations (MIL-790 by the US Military, LCSO Qualification approvals by the Indian Military), recognitions and agreements.

Hall No. : Hall A  
Stall No. : A2.2

### ROTARY ELECTRONICS PRIVATE LIMITED

Name : PARTHASARATHY PACHAIYAPPAN  
Phone : 9844038453  
Email : prathap@rotaryelectronics.com  
Website : www.rotaryelectronics.com  
Contact Person Name : Prathap Parthasarathy

#### Profile

Established in the year 1987 in Bangalore, REPL is a leading manufacturer of Sensors, Actuators & Precision Mechanical Products for Automotive & Defence applications. REPL has In-house facilities for R&D, Rapid Prototyping, Testing & Validation, Tooling, Manufacturing & Assembly to provide one stop End to End solutions to the customer.

Hall No. : Hall C  
Stall No. : C6.1,OD.06

### SAAB

Name : Irene Liander  
Email : irene.liander@saabgroup.com  
Website : www.saab.com  
Contact Person Name : Irene Liander

#### Profile

Saab is a leading defence and security company with an enduring mission, to help nations keep their people and society safe. Empowered by its 18,000 talented people, Saab constantly pushes the boundaries of technology to create a safer, more sustainable and more equitable world. Saab designs, manufactures and maintains advanced systems in aeronautics, weapons, command and control, sensors and underwater systems. Saab is headquartered in Sweden. It has major operations all over the world and is part of the domestic defence capability of several nations.

Hall No. : Hall B  
Stall No. : B5.15

### SAARC TOOL TECH PRIVATE LIMITED

Name : SUGANTHI V  
Phone : 8807060127  
Email : marketing@saarccases.com  
Website : www.saarccases.com  
Contact Person Name : SUGANTHI V

### Profile

SAARC Cases is the first company in India that makes PE Roto-Molded Cases certified by CEMILAC and cleared by DGAQA . SAARC Cases with its Two decades plus of Indigenous Engineering Experience has Designed, Engineered, Manufactured and Supplied Premium Military Grade cases to 100+customers. We understand the unique nature of every mission and the challenges that comes along with it. Hence, we provide a variety of customize case option so as to empower your every mission. We have an extensive line of End-to-End Customizable Military Grade Cases under the following Categories: Single Lid Cases: Single Lid Cases (SLC) will be ideal for protecting weapons, ammunitions, electronic equipment and life-saving medical instruments etc., Our Single Lid Cases comes in three different sub-categories: » SLC Small » SLC Medium » SLC Large Double Lid Cases: Double Lid Cases (DLC) are used for field deployment of communication equipment like amplifiers and electronic equipment. Heavy Application Cases: Heavy Application Cases under Category » Aero Engine Cases» Missile Cases »Torpedo Cases

Hall No. : Hall H  
Stall No. : H2.8

### SAMANVEE TECHNOLOGIES

Name : Sunil kumar Behara  
Email : sbehara@samtechnogroup.com  
Website : www.samtechnogroup.com  
Contact Person Name : Sunil kumar Behara

### Profile

Indigenization of LRU's, Obsolescence Management, Space Test benches, Supply of consumables

Hall No. : Hall A  
Stall No. : A3.5

### SANGHVI AEROSPACE PRIVATE LIMITED

Name : BHUSHAN SANGHVI  
Phone : 8200510421  
Email : sales.ahmd@sanghviaerospace.com  
Website : www.sanghviaerospace.com  
Contact Person Name : Rakesh Dodiya

### Profile

Sanghvi Aerospace Pvt. Ltd. (SAPL) pioneered the development and manufacturer of Polyimide insulated wires & cables for aerospace and aviation industry in 1992. The market potential was hazy. More so, the manufacturing technology was not available in India at that time. We developed these products, with our past experience of tape wrapped PTFE (Teflon) wire manufacturing, processing advise by raw material suppliers, requirements from users, guidance for test methodology & accept/ reject criteria by approving authority. The entire technology is indigenized including the manufacturing process, plant & machinery and test equipment

Hall No. : Hall B  
Stall No. : B5.22

### SANPAR MICROFILTERS PRIVATE LIMITED

Name : Mr. Sudhakaran K S  
Phone : 9379222323  
Email : sudhakaran@sanpar.com  
Website : http://www.sanpar.com/  
Contact Person Name : Nithin P S

### Profile

We take pride in introducing SANPAR - Thermal Engineering solution provider. An ISO 9001:2015 & AS 9100D Certified Company. SANPAR has been for 28 years in the field of Thermal Engineering that Conceptualise, Manufacture, Supply and Maintain the following: · Compressed Air Treatment Systems – Refrigerated / Adsorption Air Dryers, Filters, Moisture Separators, After Coolers and Drains. · Industrial Precision Air Conditioners for maintaining and controlling Humidity and temperature in a closed room; Eg. Data Centres, clean rooms · Industrial Dehumidifiers. · Industrial Chillers – Air / water / Oil/ Coolant – Air Chillers used in Ground Radar Cooling Systems. · Airborne Liquid Cooling Systems for Radar Cooling in Aircrafts. · Airborne Piping Systems. Industries catered, but not limited: Automobile & Ancillary units Pharmaceuticals Oil and Gas Data Centre Cement & Steel Power Plant Textile Machining Centre Defence & Aviation "Energy Saved is Energy Gained" has been our motto since 1994 and 3500 plus of

Hall No. : Hall G  
Stall No. : G4.4

### SAP MEDIA WORLDWIDE LIMITED

Phone : 022 4040 1919  
Email : info@sapmagazines.com  
Website : https://www.sapmagazines.com/

### Profile

SAP MEDIA WORLDWIDE LIMITED a pioneering industry related publications company catering to industry professionals and end users, is a highly diversified organisation providing an entire gamut of media related activities like publishing monthly magazines in various industry, organising exhibitions and conferences, initiating awards and bringing out Daily tabloid newspapers at all the major Conferences and Exhibitions in national and international events. All magazines have earned for themselves the sobriquet "The voice of the industry". The company is also involved in creating forums for governments, industry and customers to discuss the problems and opportunities, event management and has recently forayed into electronic publishing and specialized database and market research operations.

Hall No. : Hall H  
Stall No. : H2.5

### SASMOS HET TECHNOLOGIES LIMITED

Name : Anjali Tripathi  
Phone : 8951858867  
Email : anjali.t@sasmos.com  
Website : www.sasmos.com  
Contact Person Name : Anjali

#### Profile

SASMOS HET Technologies Limited, a Bengaluru-based manufacturer and exporter of aerospace and defence technology solutions. SASMOS is a leading design and manufacturing company for Electrical Wiring Interconnection Systems, Electromechanical assemblies & Electronic sub-systems for the Air, Land, Weapon, Marine, Space and Nuclear segments. SASMOS Defence Systems Division and Fibre Optic Division offer customized electronics, electrical, electro-mechanical mission-critical solutions and fibre optic interconnectivity products for harsh environment applications are the latest in the portfolio.

Hall No. : Hall H  
Stall No. : H4.7

### SCANDRON PRIVATE LIMITED

Name : Arjun Naik  
Phone : 7899801210  
Email : arjun@scandron.com  
Website : www.scandron.com  
Contact Person Name : Arjun Naik

#### Profile

Scandron is a DGCA Registered Drone manufacturer and provides drone based inspection and GIS services.

Hall No. : Hall A  
Stall No. : A4.6

### SCIENTIFIC MICROWAVE

Name : RAJPAL SHARMA  
Phone : 9350002915  
Email : scientificmicrowaves@gmail.com  
Website : www.smwave.com  
Contact Person Name : R.R.P. SHARMA

#### Profile

We are Manufacturers of Waveguide Made Passive Components, Custom made Microwave Components and Precision Machining Components.

Hall No. : Hall B  
Stall No. : B5.6,B5.7

### SCONCE GLOBAL PRIVATE LIMITED

Name : Anuj Yajuvendra  
Phone : 9717494986  
Email : anuj@sconceindia.com  
Website : www.keysight.com  
Contact Person Name : Amit Roy

#### Profile

Keysight delivers advanced design and validation solutions that help accelerate innovation to connect and secure the world. Keysight's dedication to speed and precision extends to software-driven insights and analytics that bring tomorrow's technology products to market faster across the development lifecycle, in design simulation, prototype validation, automated software testing, manufacturing analysis, and network performance optimization and visibility in enterprise, service provider and cloud environments. Our customers span the worldwide communications and industrial ecosystems, aerospace and defense, automotive, energy, semiconductor and general electronics. Keysight generated revenues of \$4.9B in fiscal year 2021. For more information about Keysight Technologies (NYSE: KEYS), visit us at [www.keysight.com](http://www.keysight.com).

Hall No. : Hall G  
Stall No. : G1.1

### SEC INDUSTRIES PRIVATE LIMITED

Name : Ratna Kumar P N V  
Phone : 9246101991  
Email : rathnakumar@secindustries.com  
Website : www.secindustries.com  
Contact Person Name : P N V Ratna Kumar

#### Profile

SEC Industries Pvt Ltd is a 68-year old AS9100:2016, ISO 14001:2015, ISO 9001:2015, ISO/IEC 27001:2013 and BS OHSAS 18001:2007 certified design & manufacturing enterprise engaged in the manufacture and full-system integration of complex products for the Aerospace, Defence, Naval, Space and MRO of military aircrafts sectors. Ground Support Systems • Mobile Missile launchers • Missile assembly Jigs • Missile storage and transport containers • Baro-vacuum chambers for missile leak test • Vertical Propellant mixers • Article handling trolleys • Systems – Assembly/Integration MIL Shelters • EMI/EMC shelters • UAV containers • UCS shelters Space • Assembly Fixtures for ISRO Satellite Launch Vehicles • Spacecraft Container • Shrouds, Nose cones, Fuselage Nose bodies Naval Systems • Specialised critical equipment for P-75 Scorpene submarine project, under the license from DCNS, France Airborne Products • Nose cones • Engine bays • Rocket motor casings • Wings, fans, control surfaces • Air to Air launchers • Systems – Assembly/integration The company is undertaking major MRO activities on AN-32/ Dornier aircraft at one of the BRD of Indian Air Force. Company is also undertaking production activity of "Fabrication of rear section of Dornier aircraft" at HAL, Kanpur.



Hall No. : Hall A  
Stall No. : A1.9

### SFO TECHNOLOGIES PRIVATE LIMITED

Name : Dileep Kumar S  
Phone : 9995431794  
Email : dileepkumar.s@nestgroup.net  
Website : <https://sfotechnologies.net/>  
Contact Person Name : Dileep Kumar S

#### Profile

SFO is a leading partner to international and domestic OEMs and Tier 1 companies to supply a host of Defense and Aerospace products

Hall No. : Hall B  
Stall No. : B2.2a

### SIKA INTERPLANT SYSTEMS LIMITED

Name : Kunal Sikka  
Phone : 9845003679  
Email : [aeroindia@sikaglobal.com](mailto:aeroindia@sikaglobal.com)  
Website : Sika Interplant Systems Limited  
Contact Person Name : Meena A

#### Profile

SIKA is an Aerospace & Defence focused company that offers its customers a proven track record in advanced engineered projects and systems in collaboration with International Partners including for 'Make/MRO in India.' Capabilities encompass mechanical, hydraulics, electro-mechanical, interconnect and electronics integration.

Hall No. : Hall F  
Stall No. : F4.2

### SKANDA AEROSPACE TECHNOLOGY PRIVATE LIMITED

Name : NIMISH MEHTA  
Phone : 9820525802  
Email : [accounts@skandaaerospace.com](mailto:accounts@skandaaerospace.com)  
Website : [www.skandaaerospace.com](http://www.skandaaerospace.com)  
Contact Person Name : NIMISH MEHTA

#### Profile

We are a leading AS 9100D, ISO 9001:2015 company engaged in High Precision CNC & Complex Aerospace Gear Manufacturing catering mainly to the Global Aerospace Engine & Gear markets.

Hall No. : Hall H  
Stall No. : H2.7

### SKL INDIA PRIVATE LIMITED

Name : Krishnakumar Bhatia  
Phone : 9819008947  
Email : [skl.delhi@sklindia.com](mailto:skl.delhi@sklindia.com)  
Website : [WWW.SKLEINDIA.COM](http://WWW.SKLEINDIA.COM)  
Contact Person Name : KRISHNAKUMAR BHATIA

#### Profile

We are an MSME registered, ISO certified Engineering Company with Head Office at Mumbai and a well-equipped Factory cum Workshop facility at Navi Mumbai. We are a regular supplier of Customized and Rugged MIL Gensets and Power Systems, Auxiliary Power Units & Associated Equipments for various Defence Projects and are registered with various DRDO units. Our Product range includes:- 1. Rugged Power Supply Systems 2. Light Weight, Compact and Reliable Diesel Engines and Gensets 3. APU – Combined Electrical and Hydraulic 4. Portable and Canopied Hydraulic Power Packs 5. PTO Driven Alternator – IP 67 Protection 6. Motorized and Manual Cable Drums 7. Complete Power Supply System Containers with associated Equipment 8. Hybridization and Energy Storage Systems.

Hall No. : Hall G  
Stall No. : G1.4

### SMITHS INTERCONNECT INDIA PRIVATE LIMITED

Name : Ramya Krishnappa  
Phone : 8050701475  
Email : [RAMYA.K@SMITHSINTERCONNECT.COM](mailto:RAMYA.K@SMITHSINTERCONNECT.COM)  
Website : [www.smithsinterconnect.com](http://www.smithsinterconnect.com)  
Contact Person Name : Ramya K

#### Profile

Smiths Interconnect is a leading provider of technically differentiated electronic components, subsystems, microwave, optical and radio frequency products that connect, protect and control critical applications in the commercial aviation, defense, space, medical, rail, semiconductor test, and industrial market segments. Smiths Interconnect is synonymous with exceptional performance whenever a technologically advanced, high quality solution is required to ensure reliability and safety. Smiths Interconnect has 25 Sales, R&D and Manufacturing locations in 12 countries, including Canada, US (California, Florida, Massachusetts, Kansas, and Maryland), Mexico, Costa Rica, France, Germany, Italy, UK, Tunisia, India, China, and Singapore.

Hall No. : Hall B  
Stall No. : B2.2d

### SMPP PRIVATE LIMITED

Name : Alaudin Kathat  
Phone : 9716852281  
Email : expo@smgroupindia.com  
Website : <https://smgroupindia.com/>  
Contact Person Name : Alaudin Kathat (Ali)

#### Profile

With more than 35 years of technology-driven innovation and sustained growth, SM Group has presence in diverse areas of defence: Personnel Protection (Ballistic Vests, Helmets, Armor Plates, Shields) Vehicle/Aircraft/Boat Armor A d v a n c e d Ceramic – Boron Carbide plates (for Armor) Tank Ammunition: 120mm and 125mm Artillery Ammunition: 155mm Bofors Gun, 130mm and 105mm artillery guns SMPP has one of the world's largest integrated facility for manufacturing ballistic protection solutions. We serve more than 95% of Indian market and export to several countries including France, Germany, Netherlands, Egypt, Saudi Arabia, South Korea etc.

Hall No. : Hall B  
Stall No. : B5.18

### SOFTEC SERVICES

Name : SRINIVASA RAO K  
Phone : 9845132603  
Email : softecservices@rediffmail.com  
Website : [www.softecservices.com](http://www.softecservices.com)  
Contact Person Name : SRINIVASA RAO K

#### Profile

Manufacture of Aeronautical components, desinging, etc

Hall No. : Hall F  
Stall No. : F1.13

### SOUTHERN ELECTRONICS (BANGALORE) PRIVATE LIMITED

Name : B RAM  
Phone : 08884243797  
Email : admin@seonics.co.in  
Website : [southern electronics \(bangalore\) private limited](http://southernelectronics(bangalore)private.com)

Contact Person Name : B ARAVIND RAM

#### Profile

SOUTHERN ELECTRONICS (BANGALORE) PRIVATE LIMITED is one of the largest and most established leader in providing top quality products and services in the Avionics Industries and Fire & Safety. Established in 1971, this Organisation is engaged in the Design, Development and Manufacture of Original Avionics, Ground Support Equipment, Cable Harness, Electronics and other Electro-Mechanical items used by the Armed Forces and Indian Defence Industries.

Hall No. : Hall C  
Stall No. : C5.1

### SOUTHFIELD PAINTS LIMITED

Name : Hrthpoorna Rai  
Phone : 9620225972  
Email : info@southfieldpaints.com  
Website : [www.southfieldpaints.com](http://www.southfieldpaints.com)  
Contact Person Name : Mr. Hrthpoorna Rai

#### Profile

Southfield Paints Limited, an AS 9100D & ISO 9001-2015 certified company, serving the Aerospace and Defence sectors, from the past 50 years, since 1972, is one of the leading manufacturers of "Sustainable Surface Coating Solutions" as below: Aerospace & Defence Coatings Industrial Paints Aerosol Spray Paints Auto Refinish Paints Decorative Coatings Floor Coatings Powder Coatings

Hall No. : Hall C  
Stall No. : C1.13

### SP GUIDE PUBLICATIONS PRIVATE LIMITED

Name : Neetu Dhulia  
Phone : 9810700864  
Email : neetu@spguidepublications.com  
Website : [www.spguidepublications.com](http://www.spguidepublications.com)  
Contact Person Name : Neetu Dhulia

#### Profile

"SP Guide Publications is Asia's largest publishers of Defence, Aviation & Internal Security information. The group publishes specialised magazines and are known around the world for comprehensive & unbiased coverage of news, events and other information. SP's portfolio hosts: SP's Military Yearbook (1965) - Globally renowned flagship publication (since 1964). An encyclopedia on Defence. SP's Aviation (1998) – Focus Aviation SP's Land Forces (2004) – Focus Army SP's Naval Forces (2006) – Focus Navy SP's Airbus (2008) – Focus Civil Aviation SP's MAI (2011) – Focus Army, Navy, Air Force and Homeland Security BizAvIndia (2015) – Joint publication with Business Aircraft Operators Association (BAOA) – Focus Business Aviation SP's Civil Aviation Yearbook (2017) - An indispensable reference document on civil aviation for the first time in the region. SP's ShowNews – Focus Defexpo, Aero India & Wings India For more information, please visit: [www.spguidepublications.com](http://www.spguidepublications.com) "



Hall No. : Hall H  
Stall No. : H5.2

### STAR HENTZEN COATINGS PRIVATE LIMITED

Name : DEEPAK DOSHI  
Phone : 9820038351  
Email : deepak@starhentzen.com  
Website : www.starhentzen.com  
Contact Person Name : DEEPAK DOSHI

#### Profile

Star Hentzen Coatings Pvt Ltd is Manufacturer of Paints, Topcoats, Primers, thinners and other allied products for Defence and Aerospace applications based in Mumbai, India. Defence Application Products are on QPL of MIL Spec standard like MIL-PRF-23377/MIL-PRF-85285/MIL-PRF-22750/MIL-DTL-53039/MIL-DTL-53022 & Aerospace application Specification AMS 3095/MEP 10-059/BAMS 565 Series/Meets Boeing BMS 10-72 & Airbus standard. Star Hentzen Coatings Pvt Ltd is a joint venture of Star Paint & Oil industries, India and Hentzen Coating, Inc. USA. Hentzen Coating, Inc. USA is 95 year old & largest supplier in the world to US military for MIL Specs paints. Star Hentzen is having a customer based in India & South Asia which includes Pvt Civil Airlines operators, Non-Schedule Operators, Corporate Aircrafts, MROs, Aviation Products distributors, Defence Equipment Manufacturer, Shelter Manufacturer, K9 Vajra Tank & Guns Manufacturer, Missile Launchers & OE Component manufacturer for Boeing, Sikorsky, Lockheed Martin, UTC. SHCPL is AS 9100:2016 & ISO 9001:2015 accredited company.

Hall No. : Hall H  
Stall No. : H5.1

### STAR PAINT & OIL INDUSTRIES

Name : NILESH DOSHI  
Phone : 9820135054  
Email : nilesh@starpaintindia.com  
Website : www.starpaintindia.com  
Contact Person Name : NILESH DOSHI

#### Profile

: Star Paint & Oil Industries is a Paint manufacturer since the last 80 Years, specialists in manufacturing of Industrial & Heat Resisting Paints as per Indian Standard Specifications as well as International Specifications We have developed for the 1st time in India Heatex Aluminum & Black Paint heat resisting upto 600 deg C We have also developed special paints & varnishes for Hindustan Aeronautics Ltd. Indian Air Force for various Divisions, Bharat Electronics Limited and other DPSUs Some of our items are Type approved by CEMILAC Ministry of Defence, New Delhi. EP-140, KO-83, BL-725, KO-915, KO-811, KO-813, KO-814, KO-815, AK-113, PF-223 STAR HEATEX, STARPOXY, STARHANE and others for We have been awarded by SIATI for Excellence in Aerospace Indigenisation & HAL, Koraput Division for meritorious contribution towards indigenisation activities. Moreover, the said paint is used by Aircraft Industries, Air Force, and Navy. Huge amount of Foreign Exchange is saved as most of our products are import substitution.

Hall No. : Hall A  
Stall No. : A2.9

### STAR WIRE INDIA LIMITED

Name : P N Singh  
Phone : 9350150755  
Email : pnsingh@starwire.in  
Website : Star Wire India Ltd  
Contact Person Name : P N Singh

#### Profile

Star Wire India Ltd is a leading manufacturer of specialty steels and Super alloys for strategic application like Defense, Aerospace and Nuclear sectors and significantly contributed by way of Import substitution under "Make in India". We are having Melting, Rolling, Forging, Heat treatment, Machining and Testing facilities in house. The steel manufacturing through Electric Arc Furnace, Argon Oxygen Decarburizing Converter, Ladle Refining Furnace and Vacuum Degassing Unit ensures clean steel with low sulphur, phosphorus and gas level in primary melt and this can be further remelted in our modern ESR OR VAR furnaces which in turn helps in achieving better quality of forge & rolled products. We are having 2000 Ton open die forging press and 12000 ton close die forging press. For supply of advanced high-tech materials to strategic industries, we have VIM (Vacuum Induction Melting) furnace for 3.00/8.00MT. We are AS:9100D certified company and Lab is accredited by NABL.

Hall No. : Hall C  
Stall No. : C3.10

### STEIN SEAL COMPANY INDIA PRIVATE LIMITED

Name : MUTHURAMALINGAM PADALINGAM  
Phone : 7676217341  
Email : mrl@steinseal.in  
Website : WWW.STEINSEAL.IN  
Contact Person Name : MUTHURAMALINGAM

#### Profile

Mechanical seal manufacturer

Hall No. : Hall A  
Stall No. : A3.3

### STRONGFIELD TECHNOLOGIES INDIA PRIVATE LIMITED

Name : SIDDESHA HANUMANTHAPPA  
Phone : 9844245588  
Email : siddesha@strongfield.com  
Website : https://www.strongfield.com/  
Contact Person Name : SIDDESHA HANUMANTHAPPA

### Profile

The Strongfield Group has been operational since 30 years with its head office is in the United Kingdom, with branch offices & operations in Europe, MENA, Canada, USA, China & India. India n Office located at Mittal Towers, MG Road Bangalore is operational since 2015. STIPL deals with all major Defence, Govt of India institutions and private sectors. STRONGFIELD had partnered with major Aviation and Defence OEMs to cater for Indian customers. The customers' requirements are outsourced from OEM's across the world to bring in the best technology in terms of new product Development and Supply. STRONGFIELD holds exclusive marketing and distribution rights for India through Defence OEMs' across the globe. Technologies & Component Sourcing is one of the key areas of operation Our procurement team has great reach across the world and can source any part from any corner in the world.

Hall No. : Hall F  
Stall No. : F.1.2

### SUMAN CONTROLS PRIVATE LIMITED

Name : M R BHASKAR  
Phone : 7829450612  
Email : marketing@sumancontrols.com  
Website : www.sumancontrols.com  
Contact Person Name : M R BHASKAR

### Profile

Suman Controls Pvt Ltd established in 1991 and is located in Peenya Industrial Area, Bengaluru & continuing its business with rapid growth in electrical products of instrument transformers (Current Transformer, Potential Transformer, CTPT Metering Units & Other High Voltage Transformers) all our products are type tested at CPRI and being supplied to various electricity board's in India and other major Turnkey Power Projects.

Hall No. : Hall H  
Stall No. : H3.1

### SWASTIK OIL PRODUCTS MFG NAVSARI PRIVATE LIMITED

Name : MITESH RATHOD  
Phone : 9426313461  
Email : MITESH@SWASTIKOIL.COM  
Website : WWW.SWASTIKOIL.COM  
Contact Person Name : MITESH RATHOD

### Profile

SWAST AVIATION is one of the leading manufacturers, developers and suppliers of Aviation Lubricants as per the most stringent military standards across the globe.

Hall No. : Hall C  
Stall No. : C2.5

### TAMBOLI CASTINGS LIMITED

Name : VICKY PANDITA  
Phone : 9099922424  
Email : bis.dev@tcl.in  
Website : https://www.tcl.in/  
Contact Person Name : VICKY PANDITA

### Profile

Investment Castings manufacturing company as well as an Export Oriented Unit and has a high degree of automation for highly laborious processes such as robotic systems for ceramic coating, in-house facility for making complex ceramic cores and a modern CNC Machine Shop.

Hall No. : Hall A  
Stall No. : A8.6,A8.7,A7.1,A6.4

### TAMIL NADU INDUSTRIAL DEVELOPMENT CORPORATION

Name : V Vinayagam  
Phone : 9840937273  
Email : vvtndic@tidco.com  
Website : https://www.tidco.com/  
Contact Person Name : V Vinayagam

### Profile

TIDCO facilitates large industrial and infrastructure projects in Tamilnadu involving large investments and huge employment potential. TIDCO is the Nodal Agency for the development of Tamil Nadu Defence Industrial Corridor.

Hall No. : Hall C  
Stall No. : C3.4

### TARANG KINETICS PRIVATE LIMITED

Name : Akshat Jain  
Phone : 9760025259  
Email : info@tarangkinetics.com  
Website : www.tarangkinetics.com  
Contact Person Name : Akshat Jain

### Profile

Tarang kinetics is a leading destination for environmental testing solutions since 1995. With a glorious history of nearly 3 decades of excellence in the manufacturing of testing solutions such as Electrodynamic Vibration Shaker System , Bump Test Machine , Shock Test Machine, Linear Acceleration Machines etc. We customize testing solutions as per customer's stringent application requirement to test every/any end product under a

simulated environment in the laboratory. Using our testing solutions at the design and production phase provides the confidence that our customers need to develop highly reliable products. Tarang has progressed to become a pioneer in delivering comprehensive testing capabilities with accuracy and reliability. Tarang has always been acknowledged for its excellence. We have been Indigenously Designing & Manufacturing various testing systems and making INDIA stronger. MAKE IN INDIA We are empowered with a competent production team, whose extensive experience and technical expertise makes us the top choice of leading industries. Tarang follows a strong customer – focused approach by delivering tailored solutions to suit the exact application needs of our clients. We have been innovating to stay ahead of the technology curve and constantly reinventing our approach to meet the needs of the dynamic business environment. Providing exceptional customers service that meets and exceeds their expectations remains at the core of our business. Our R&D Facility is in constant efforts of expanding our product line to meet the over increasing application demands of our customers.

Hall No. : Hall G  
Stall No. : G3.3

### TARGET AERO PRIVATE LIMITED

Name : ANURAG CHAUHAN  
Phone : 9910531506  
Email : anurag@targetaero.com  
Website : www.targetaero.com  
Contact Person Name : ANURAG CHAUHAN

#### Profile

Distributor for Spartech USA, Consolite Technology UK, Sabic, Berry Global, Hermith Titanium & Ensinger India. Suppliers of all types of acrylic sheets & bars, cockpit NVG/NVIS lighting & filters, aerospace tapes, polycarbonate sheets & bars, titanium bars, plates & tubes.

Hall No. : Hall G  
Stall No. : G5.1 - 5.6

### TATA ADVANCED SYSTEMS LIMITED

Name : Ameya Kamat  
Phone : +91-9223529689  
Email : akamat@tataadvancedsystems.com  
Website : www.tataadvancedsystems.com  
Contact Person Name : Mr. Ameya J Kamat

#### Profile

Tata Aerospace & Defence is one of the country's leading private players for aerospace and defence solutions and aspires to be the 'Partner of Choice', especially for the government's 'Make in India' programme and for global Original Equipment Manufacturers (OEMs). With the requisite capabilities, resources and scale, it is equipped to deliver end-to-end innovative solutions encompassing

systems, hardware, software, technology and digital solutions, all of which can be fully integrated across the key platforms necessary to secure India's land, sea and skies. Tata A&D offers a full range of integrated solutions across Aerostructures & Aeroengines, Airborne Platforms & Systems, Land Mobility Solutions, Weapon Systems, Sensors & C4I Solutions and Physical & Cyber Security Solutions The Tata group has served as a trusted partner to India's armed forces for over six decades and will continue to provide world-class standards of quality and delivery that the Tata name is known for.

Hall No. : Hall C  
Stall No. : C4.5

### TE CONNECTIVITY INDIA PRIVATE LIMITED

Name : SUMIT SAURABH  
Phone : 7619223054  
Email : sumit.saurabh@te.com  
Website : https://www.te.com/usa-en/home.html  
Contact Person Name : Sumit Saurabh

#### Profile

TE Connectivity India is a component manufacturer for Aerospace, Defense and marine application.

Hall No. : Hall C  
Stall No. : C2.10

### TECHERA ENGINEERING (INDIA) PRIVATE LIMITED

Name : Meet Desai  
Phone : 7774084431  
Email : sonalishelar@techera.co.in  
Website : www.techera.co.in  
Contact Person Name : Sonali Shelar

#### Profile

TechEra Engineering India Pvt Ltd are born into Aerospace and Defence Tooling Manufacturing business. We are a value based organisation and our greatest asset has always been our people. We are focused on doing business, manufacturing excellent products for our customers with emphasis on honesty and integrity, which has always been our core strength. The key product/processes/services he has been a part of are:

- Aerospace and Defence Tooling for TEJAS Aircraft – Indian Defence
- Defence Tooling for Airplane Wing, Airplane Fuselage, Airplane Component Fixtures and Tooling
- Ground Support Equipment for Rafale Aircraft – Indian Defence
- Automation: Vehicle Engine Assembly Lines • Vehicle Axle Assembly Lines • SPM's for various Automotive Applications • Press Machines and Tooling • Engine Pallets

Hall No. : Hall G  
Stall No. : G1.5

### TECNOMIC COMPONENTS PRIVATE LIMITED

Name : Pawan Machaiah  
Phone : 080 2528 6934  
Email : pawan@tecnomic.com  
Website : www.tecnomic.com  
Contact Person Name : Pawan Machaiah

#### Profile

Tecnomnic Components is a trusted regional demand creation distributor in South East Asia and India for some of the leading brands in the global electronic component industry.

Hall No. : Hall G  
Stall No. : G2.1

### TESBL AEROSPACE

Name : Gopi Seti  
Phone : 8904737405  
Email : gopi@tesbl.com  
Website : www.tesbl.com  
Contact Person Name : Dr Gopi Seti

#### Profile

Original Equipment Manufacturer (OEM)

Hall No. : Hall B  
Stall No. : B5.17b

### THE ACCESSORIES

Name : Anish Agarwal  
Phone : 9830197524  
Email : anish@aeroarmour.store  
Website : www.aeroarmour.store  
Contact Person Name : Anish Agarwal

#### Profile

We at Aero Armour Store are driven by our passion for adventure. We are aviators, patriots, adrenaline junkies and travellers who bring to you a great collection of products to celebrate this passion.

Hall No. : Hall B  
Stall No. : B5.1

### THE BHOR CHEMICALS AND PLASTICS PRIVATE LIMITED

Name : PAYAL FIRODIYA  
Phone : 7045297847  
Email : pfirodiya@bhor.com  
Website : https://bhor.com/  
Contact Person Name : PAYAL FIRODIYA

#### Profile

The Bhor Chemicals and Plastic Pvt. Ltd. is the manufacturer of reinforcement Fabrics, Prepregs, Resins, Pultruded Profiles and specialty chemicals for composites. Bhor's Product Range: • Reinforcement Fabrics: Carbon Fiber Woven Fabrics, Aramid Fiber Woven Fabrics, Glass Fiber Woven Fabrics, Quartz Fiber Woven Fabrics, Hybrid Fabrics, Narrow Width Dry Fabric Tapes • Prepregs: Epoxy Prepregs, Cyanate Ester Prepregs • Pultruded Profiles: Carbon Fiber Laminates, Carbon Fiber Rods, Carbon Fiber Tubes and Sheets • Epoxy Resin Systems: Epoxy Resins for Composites, Epoxy Resins for Structural Strengthening and Retrofitting • Specialty Products: Adhesive Films for Bonding Core Materials • Kits: Vacuum Bagging and Resin Infusion Kits • N A B L Certified Testing: Textile Materials, Polymers & Plastics, Fiber Reinforced Plastic Products

Hall No. : Hall A  
Stall No. : A4.1

### THE SOCIETY FOR AEROSPACE STUDIES

Name : Vikramjit Singh Chopra  
Phone : 9811155978  
Email : vayuaerospace@lycos.com  
Website : www.vayuaerospace.in  
Contact Person Name : Vikramjit Singh Chopra

#### Profile

SAS brings out the Vayu magazine that is now in its 49th year of publication. The magazine covers all aerospace and defence matter in India as well as the rest of the world.

Hall No. : Hall F  
Stall No. : F3.6

### THERMOVAC AEROSPACE PRIVATE LIMITED

Name : MANJUNATHA S J  
Phone : 9590099550  
Email : marketing@thermovacaerospace.com  
Website : https://thermovacaerospace.com/  
Contact Person Name : Ranjith A S



### Profile

Thermovac Aerospace Private Limited, an AS9100D & BS EN ISO 9001:2015 "One Stop Thermal Solutions Providers" for the emerging needs in Thermal Processing through excellence in design and innovation. Since 2016, We are successful in providing the quality thermal solutions for the companies across the globe ranging from small to large delivering the precised solution for our customers.

Hall No. : Hall A  
Stall No. : A3.9

### THIRD WAVE RUGGEDTECH PRIVATE LIMITED

Name : Shaurin Soni  
Phone : 9328283304  
Email : info@thirdwaveruggedtech.com  
Website : www.thirdwaveruggedtech.com  
Contact Person Name : Shaurin Soni

### Profile

Third Wave is a brand name that is adequate to deploy with cutting-edge ruggedized devices to cater all your needs in harsh environments. We are certainly a trailblazer in innovating systems that can redefine the rugged computing solutions for world-class reliability. Third Wave introduced the first tablet device in 2016, which for several years had been one of the best fully rugged tablet available in the Indian market. It has all the durability, potential and security you've come to expect from Third Wave, so be confident that you are in control of your technology.

Hall No. : Hall C  
Stall No. : C6.2

### THREYE INTERACTIVE PRIVATE LIMITED

Name : Threye Interactive  
Phone : 8369659025  
Email : aeroind23@threye.com  
Website : http://www.threye.com/  
Contact Person Name : Siddhesh Naik

### Profile

Threye Interactive is an award winning computer game development studio making mobile games and doing venture works in the field of augmented and virtual reality related to the aerospace sector.

Hall No. : Hall B  
Stall No. : B5.31

### TIMETOOTH TECHNOLOGIES PRIVATE LIMITED

Name : Girish Mudgal  
Phone : 09910339215  
Email : girish@timetooth.com  
Website : TIMETOOTH TECHNOLOGIES PVT LTD  
Contact Person Name : Sufian Ahmed

### Profile

Timetooth is a leading engineering solutions company partnering with technology-driven organizations to develop challenging high-performance products for the Aerospace, Defence, Medical and Vehicle industries.

Hall No. : Hall B  
Stall No. : B5.13

### TRASCCON INTERCONNECTION SYSTEMS PRIVATE LIMITED

Name : Rudrappa Mirekar  
Phone : 9740014532  
Email : rudrappa.mirekar@trasccon.com  
Website : https://www.trasccon.com  
Contact Person Name : Rudrappa Mirekar

### Profile

Manufacturer of Electrical Interconnection systems such as Wire Harness, Cable Assembly, Electrical Looms, Cabinet wiring and Electro Mechanical Integrations.

Hall No. : Hall F  
Stall No. : F5.3

### TRENTAR PRIVATE LIMITED

Name : Balamurugan Subramanian  
Phone : 9741104467  
Email : kam.home@trentar.com  
Website : https://trentar.com/  
Contact Person Name : Balamurugan Subramanian

### Profile

Trentar is a vertically integrated organization with in-house R&D, design, software, firmware, manufacturing, services and training operation. Trentar is also backward integrated from the services to the platforms to the subsystems. The group companies of Trentar are continually innovating and experimenting to transform its aerial platforms to offer greater performance, higher reliability and autonomy. Through their products and services, we aim to establish the world where humans and UAV's work together in a sustainable way. We create services and revolutionary UAV's with our superior technology and unrivaled technical expertise in the commercial & defense industry. Our goal is to become the # 1 unmanned system manufacturer in the world and drive change through continuous innovation.



Hall No. : Hall A  
Stall No. : A4.10,A4.11

### TRIDENT INFOSOL PRIVATE LIMITED

Name : Praveen Kumar  
Phone : 7259132850  
Email : praveen.kh@tridentinfosol.com  
Website : <https://tridentinfosol.com/>  
Contact Person Name : Praveen

#### Profile

Trident Infosol offers a Single Source for all your development needs related to Software, Hardware, Design Services and Fully Integrated Systems for a range of Applications. We are an End-to-End Solution provider catering to your complete product development life-cycle right from concept design to final acceptance test and beyond - meeting customer requirement specifications and standards, assuring continued product support. Our approach towards optimized and fully integrated solution has helped us develop a unique competence to fulfill our customers' requirement specifications, which helps our customers to deploy their systems faster. We offer solutions for a wide range of application serving the Aerospace, Defense, Research & Development, Automotive, Telecommunications, Medical and Industrial segment.

Hall No. : Hall E  
Stall No. : E.4.4,E.4.7

### TROOP COMFORTS LIMITED

Name : SANTHOSH KUMAR SINHA  
Phone : 9025121493  
Email : psenthilkumar@ord.gov.in  
Website : <https://www.troopcomfortslimited.co.in/>  
Contact Person Name : P Senthil Kumar

#### Profile

Troop Comforts Limited is a Public Sector Undertaking incorporated on 16th August 2021 under the companies Act, 2013(18 of 2013) with 100 % equity share held by Government of India. It is involved in manufacture of Life Cycle Clothing (LCC), Extreme Cold Climate Items (ECC), Special Clothing & Mountaineering Equipment (SCME), Supply Drop Equipment (SDE), Water Storage Equipment, Covers, Tentages, Leather Items, Arrester Barrier, General Stores, etc for Defence Services and Civil Sector.

Hall No. : Hall H  
Stall No. : H1.1

### TURBO CAST INDIA PRIVATE LIMITED

Name : Ramji Mavani  
Phone : 9825107090  
Email : info@turbo-cast.com  
Website : [www.turbo-cast.com](http://www.turbo-cast.com)  
Contact Person Name : Ramji Mavani

#### Profile

Turbo Cast (India) Pvt. Ltd. is India's First Indigenous Investment Casting foundry, started in 2015, especially for Aerospace, Defense, Medical & Aluminum Alloy, Accredited for AS9100D & Nadcap (NDT) & Nadcap (Welding) Certification. We have applied for Nadcap (Heat Treatment) & Nadcap (Radiography Testing) and planned to get both Certifications by March 2023. We have in-house Tool Manufacturing & CNC Machining Facility.

Hall No. : Hall A  
Stall No. : A2.11

### TURBO INDIA INTERCONNECT SOLUTIONS LLP

Name : Pushpalatha H  
Phone : 6360162847  
Email : accounts@turboindia.co.in  
Website : TURBO INDIA INTERCONNECT SOLUTIONS LLP  
Contact Person Name : PUSHPALATHA

#### Profile

Turbo India Interconnect Solutions (TICS) - subsidiary of Turbo India, is an AS9100 certified company. specialized in manufacture and supply of Connectors, Backshells, Protective Covers, Electrical Contacts and Components for Military, Aerospace and Industrial applications, against standard and custom requirements. Headquartered in Bangalore, India, the 2500 sq.m. facility is equipped with adequate infrastructure for the design, manufacture, assembly, testing and inspection of interconnect products. The long-standing manufacturing expertise of the Turbo group, spanning over two decades since 1996, supporting the Military and Aerospace industry, equips TICS to work in collaboration with its customers to offer a complete solution.

Hall No. : Hall H  
Stall No. : H1.2

### TURBO2 CAST PRIVATE LIMITED

Name : Ramji Mavani  
Phone : 9825107090  
Email : info@turbocastings.com  
Website : [www.turbo-cast.com](http://www.turbo-cast.com)  
Contact Person Name : Ramji Mavani

### Profile

Turbo2 Cast Pvt. Ltd. is Manufacturers of Ferrous & Nonferrous Investment Castings & High Precision Machined Components in India.

Hall No. : Hall B  
Stall No. : B5.19

### UCAM PRIVATE LIMITED

Name : Varun Dev  
Phone : 9845966277  
Email : marketing@ucamind.com  
Website : www.ucamind.com  
Contact Person Name : Pradyumna

### Profile

We are manufactures of 4th and 5th Axis Rotary Table

Hall No. : Hall C  
Stall No. : C3.1,C3.2

### UNIFIED ELECTRO TECH PRIVATE LIMITED

Name : SUDHIR KUMAR  
Phone : 9620900448  
Email : kumar.s@unified.co.in  
Website : www.unified.co.in  
Contact Person Name : SUDHIR KUMAR

### Profile

Unified, a customer-focused top electronic components distributor was started in the Year 2000 by a group of Technocrats. It is now a familiar and popular name in the Indian Defence, Aerospace and Telecom segment. Since our inception, we have grown rapidly to become a trusted partner for the D&A Design and production houses in India. We market Industrial, MIL and Space qualified Active & Passive components to all the major industries, and our products range from RF Components, Electro-Mechanical Components, Passive Components, Power Modules, to Interconnect Components and Wireless Products. We cater to all your industry needs, with a strong presence and contracts in defence, space, industrial, automotive, and many other segments.

Hall No. : Hall G  
Stall No. : G3.6

### UNIFIED GLOBALTECH (INDIA) PRIVATE LIMITED

Name : Tarun Mehta  
Phone : 9341046999  
Email : tarun@unified.co.in  
Website : www.unified.co.in  
Contact Person Name : Tarun Metha

### Profile

Unified, a customer-focused top electronic components distributor . Since our inception, we have grown rapidly to become a trusted partner for the D&A Design and production houses in India. We market Industrial, MIL and Space qualified Active & Passive components to all the major industries. Our products range from RF Components, Electro-Mechanical Components, Passive Components, Power Modules, Interconnect and Wireless Products. We cater to all industry like Defence, space, industrial, automotive, Railways, Telecom, Automation and many other segments. Our philosophy, Committed to Excellence, has guided us through the years and helped us grow into an industry-wide, ever-present organization, with top principles and brands. Our vision is to become a global leader in the industry and to provide Hi-tech solutions and products, with a consistent focus on our customers and becoming a one-stop solution for all. We believe in our motto and the success it has bought us – United We Grow! .We have a highly skilled Staff as Product managers, Field application Engineers and techno Commercial Sales team pan India.

Hall No. : CHALET  
Stall No. : 34

### UNITED AIRCRAFT CORPORATION

Name : Elena Mazurkevich  
Email : hinta@mail.ru  
Website : www.uacrussia.ru/en/  
Contact Person Name : Leonid Dimlevich

### Profile

The priority activity areas of PJSC UAC and its member companies are: development, production, sales, operational support, warranty and servicing, modernization, repair, and disposal of civil and military aircraft.

Hall No. : Hall E  
Stall No. : E.3.1B

### UTTAR PRADESH EXPRESSWAYS INDUSTRIAL DEVELOPMENT AUTHORITY

Name : Uttar Pradesh Defence Industrial Corridor  
Email : defcorup.project@gmail.com  
Website : <https://upeida.up.gov.in/updic/>  
Contact Person Name : MR. RAKESH SHARMA

#### Profile

Understanding the inevitable requirement of self-reliance in Defence and Aerospace sector with everchanging geopolitical scenario, Uttar Pradesh Defence Industrial Corridor, an ambitious project under an Authority named "Uttar Pradesh Expressways Industrial Development Authority" (UPEIDA), under UP Industrial Area Development Act 1976, was launched in 6 districts as Lucknow, Kanpur, Aligarh, Agra, Chitrakoot and Jhansi called the Defence nodes to make UP, The Aerospace & Defence manufacturing Hub.

Hall No. : Hall G  
Stall No. : G1.3,G1.2

### V J IMAGING TECHNOLOGIES PRIVATE LIMITED

Name : Satya Sree Korlipara  
Phone : 9972384064  
Email : smane@vjt.com  
Website : VJT.COM  
Contact Person Name : Prashanth Rajanna

#### Profile

OEM, Xray Imaging System and inspection service and supplying to NAVY, Aero space,

Hall No. : Hall B  
Stall No. : B5.17

### V V HITECH INNOVATIONS INDIA PRIVATE LIMITED

Name : gaudhaman ramaswamy  
Phone : 9952401293  
Email : sales@vvhitechhoses.in  
Website : [www.vvhitechhoses.in](http://www.vvhitechhoses.in)  
Contact Person Name : Nisha

#### Profile

we are the manufactures and specailist of hitech industrail ductings and hoses and clamps

Hall No. : Hall B  
Stall No. : B5.2

### VAR ELECTROCHEM PRIVATE LIMITED

Name : RAGHUVARMA KOTHAPALLY  
Phone : 9948108449  
Email : r.varma@varelectrochem.in  
Website : [www.varelectrochem.in](http://www.varelectrochem.in)  
Contact Person Name : K RAGHUVARMA

#### Profile

VAR is established in the year 1997. Main product line: Thermal Batteries QMS ISO 9001:2015. Till now supplied Thermal Batteries to: - BDL: MILAN, AKASH, KONKUR, INVAR, QRSAM, AKASH NG, etc. DRDO: NGARM, SFDR, AKASH, TRISHUL, ASTRA, AKASH NG, QRSAM, RUDRAM-II, SUDARSHAN, NIRBHAY, HELINA, STAR, PGAD-I, etc. Entered into Joint Venture with ASB GROUP, France in 2017. VAR can provide designs which meet the customer expectations by leveraging the experience of our development teams and extensive use of modelling tools developed in-house which results in robust products with excellent performance margins. VAR is equipped with state of art facilities which are standard across the group and include: full traceability, statistical process control, 100% final inspection. The Equipment involve: controlled atmospheric glove box trains, dry rooms, powder processing, process Atomization, etc. Test Equipment: • 100% non-destructive testing (X-RAY) • Load banks with data loggers, vibration, bump, environmental chambers, acceleration, jolting, etc.

Hall No. : Hall A  
Stall No. : A4.2

### VEER-O-METALS PRIVATE LIMITED

Name : Gaurav Rai  
Phone : +91-8299637255  
Email : info.jlh@veerometals.com  
Website : [www.veerometals.com](http://www.veerometals.com)  
Contact Person Name : Gaurav Rai

#### Profile

Veer O Metals is an AS9100D certified company located in Bengaluru, India with 5 decades of experience in Aerospace & Defence Industry; we are a one-stop shop for Precision Metal Parts & Assemblies/Sub-Systems and components. Strengths • Strong design and engineering capabilities. • 35,000 sq. mts. of manufacturing facilities. • Integrated facility - including Machining- 4+1 axis VMCs, CNC Turning Centres, SPMs. Precision Metal fabrication- Fibre Laser, CNC Turret Punch, CNC Bending, TIG, MIG welding, specialised riveting Press shop and toolroom. Painting (Wet Painting & Powder coating). Assembly. Metal 3D Printing (Additive Manufacturing) • Exporter and IoP for mechanical sub-assemblies and components. Exports to USA, Europe, Israel and Australia.

Hall No. : Hall C  
Stall No. : C6.3

### VEM TECHNOLOGIES PRIVATE LIMITED

Name : Col Aman Kaushal (Retd)  
Phone : 8716888864  
Email : sales@vemtechnologies.com  
Website : www.vemtechnologies.com  
Contact Person Name : Col Aman Kaushal (Retd)

#### Profile

VEM was instituted in 1988 and since grown in diversified technological fields to manufacture the state of art high reliable systems for aerospace for defence.

Hall No. : Hall H  
Stall No. : H2.2

### VINYAS INNOVATIVE TECHNOLOGIES PRIVATE LIMITED

Name : Manoj Kumar  
Phone : 9606881092  
Email : manojkumar@vinyasit.net  
Website : www.vinyasit.com  
Contact Person Name : Dimple Ashok

#### Profile

Incorporated in 2001, Vinyas Innovative Technologies is a leading provider of design, engineering and electronics manufacturing services catering to global Original Equipment Manufacturers and Original Design Manufacturers in Electronic Industry. As an integrated electronic manufacturing services provider, Vinyas offers a broad range of products and services across multiple industry segments for about 20 years. With wide industry knowledge, cutting-edge technologies & state-of-the-art infrastructure, Vinyas supports its Global partners from conceptualizing the design, engineering, manufacturing to turnkey requirements for mission-critical applications. Continuously investing in strengthening its design & manufacturing expertise, Vinyas is identified as a game changer in EMS industry for its innovative and in-house path breaking solutions to complex manufacturing processes. Focusing on quality, integrity and hard work, Vinyas has not only established a Global network of suppliers and customers but also creat

Hall No. : CHALET  
Stall No. : CHALET.41

### ZEALTEK ENTERPRISES PRIVATE LIMITED

Name : Ravinder Kaur  
Phone : 9891178955  
Email : ruby@dynatronservices.com  
Website : www.crowncorp.in  
Contact Person Name : Ravinder Kaur

#### Profile

The Crown Group – Defence Engineering Division: Established in 1978, Crown Group is a professionally managed Group with active businesses in Defence Engineering, IT, & Infrastructure Sectors. The Crown Group is a technology provider, infrastructure developer, manufacturer and strategic partner operating in the defence & industrial sector in India. Professional executive team with vast experience in diversified fields support functions across all business divisions. The Crown Group will be the leading Indian Manufacturer, Service Provider and reliable Indian partner to the Indian Defence forces and international OEM's prepared to participate in India's "Make In India" vision by offering the highest proven standards of integrity, reliability and client satisfaction. To establish Crown Group as a preferred partner in India for global enterprises engaged in Defence Engineering and such other sectors where the Group is actively operational including Infrastructure development and customised AI & IT solutions.

Hall No. : CHALET  
Stall No. : CHALET.36

### ZEN TECHNOLOGIES LIMITED

Name : Anusha M  
Phone : 8331011331  
Email : anusha.m@zentechnologies.com  
Website : www.zentechnologies.com  
Contact Person Name : Surya Prakash

#### Profile

Incorporated in 1993, Zen Technologies Limited designs, develops and manufactures state-of-the-art combat training solutions for the training of defence and security forces worldwide. Zen Technologies is headquartered in Hyderabad, India with offices in India and USA. Zen Technologies produces over 40 different Live Fire, Live Instrumented, Virtual and Constructive training systems to support individual and collective training capabilities. With over 1,000 training systems shipped around the world, Zen Technologies is a proven leader in building training systems for developing and measuring Combat Readiness. Zen Technologies is built on strong R&D capabilities and has filed or received over 90 patents. Zen Technologies Limited is an ISO 9001:2015 (QMS), ISO/IEC 27001:2013 (ISMS) and CMMI Maturity Level 5 company.

Hall No. : Hall F  
Stall No. : F3.3

### ZEPHYR AEROSPACE PVT. LTD.

Name : Simonyl Kaula  
Phone : 9600870740  
Email : kalyanraman@zephyr-aerospace.in  
Website : ZEPHYR AEROSPACE PVT LTD  
Contact Person Name : KALYAN RAMAN

#### Profile

Aerospace service provider

## NOTES

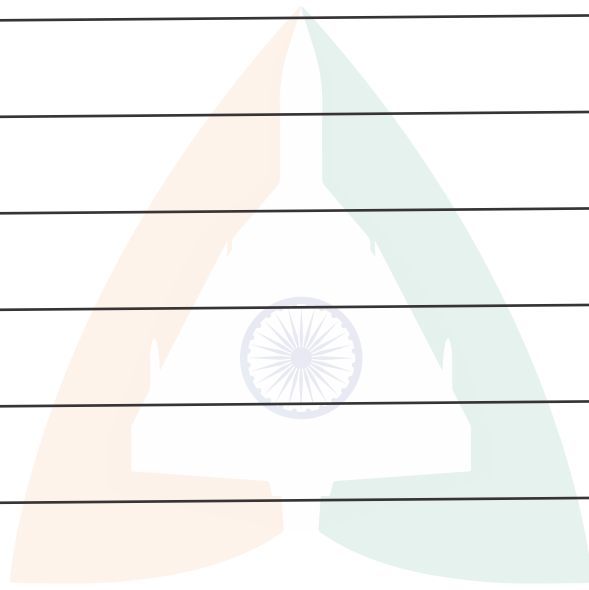

2023

**AERO INDIA**

The Runway to a Billion Opportunities





2023

# AERO INDIA

The Runway to a Billion Opportunities